

Safety Instructions & Operator's Manual for **SNAPPER**[®]

MID MOUNT Z-RIDER ZERO TURNING HYDRO DRIVE SERIES 2



MODELS

NZM19482KWV
NZM21522KWV
NZM25612KWV
NZM27612KH

MODEL NUMBER EXPLANATION

N **Z** **M** **19** **48** **2** **KWV**

MODEL DESIGNATION

DRIVE SYSTEM TYPE

MOWER ORIENTATION

ENGINE HP *

ENGINE TYPE

SERIES DESIGNATION

MOWER DECK SIZE

POWER UNIT

N – Model Designation	19.0 – Engine Horse Power	48 – 48" Mower Width	2 – Series Designation
Z – Zero Turning – Hydro Drive	21.0 -- Engine Horse Power	52 – 52" Mower Width	KW – Kawasaki Engine
M – Mid Mount Mower	25.0 – Engine Horse Power	61 – 61" Mower Width	KH – Kohler Engine
	27.0 – Engine Horse Power		V – Over Head Valve

Thank you for buying a SNAPPER Product! Before operating your machine, read this manual carefully and pay particular attention to the "IMPORTANT SAFETY INSTRUCTIONS" on Pages 2 - 4. Remember that all power equipment can be dangerous if used improperly. Also keep in mind that SAFETY requires careful use in accordance with the operating instructions and common sense!

NOTE: Specifications are correct at time of printing and are subject to change without notice.

* Actual sustained equipment horsepower will likely be lower due to operating limitations and environmental factors.

SNAPPER McDonough, GA., 30253 U.S.A.

COPYRIGHT © 2004
SNAPPER – A DIVISION OF SIMPLICITY MFG., INC.
ALL RIGHTS RESERVED

MANUAL No. 7-4408 (Rev. 1 - 9/3/04)



IMPORTANT SAFETY INSTRUCTIONS



WARNING: This powerful cutting machine is capable of amputating hands and feet and can throw objects that can cause injury and damage! Failure to comply with the following **SAFETY** instructions could result in serious injury or death to the operator or other persons. The owner of the machine must understand these instructions and must allow only persons who understand these instructions to operate machine. Each person operating the machine must be of sound mind and body and must not be under the influence of any substance, which might impair vision, dexterity or judgment. If you have any questions pertaining to your machine which your dealer cannot answer to your satisfaction, call or write the Customer Service Department at SNAPPER, McDonough, Georgia 30253. Phone: (1-800-935-2967).

PROTECTION FOR CHILDREN

Tragic accidents can occur if the operator is not alert to the presence of children. Children are often attracted to the machine and the mowing activity. Never assume that children will remain where you last saw them.

1. **KEEP** children out of the mowing area and under the watchful care of a responsible adult.
2. **DO NOT** allow children in yard when machine is operated (even with the blades OFF).
3. **DO NOT** allow children or others to ride on machine, attachments or towed equipment (even with the blades OFF). They may fall and be seriously injured.
4. **DO NOT** allow pre-teenage children to operate machine. Local regulations may restrict the age of the operator.
5. **ALLOW** only adults or responsible teenagers with mature judgment under close adult supervision to operate machine.
6. **DO NOT** operate blades in reverse. **STOP BLADES. LOOK and SEE** behind and down for children, pets and hazards before and while backing.
7. **USE EXTRA CARE** when approaching blind corners, shrubs, trees, or other objects that may obscure vision.

PROTECTION AGAINST TIPOVERS

Slopes are a major factor related to loss-of-control and tip-over accidents, which can result in severe injury or death. All slopes require extra **CAUTION**. If you cannot back up the slope or if you feel uneasy on the slope, **DO NOT** mow it. Use extra care with grass catchers or other attachments; these and turf conditions affect the handling and the stability of the machine.

1. **DO NOT** operate machine on slopes exceeding 15 degrees (27% grade).
2. Exercise **EXTREME CAUTION** on slopes above 10 degrees (18% grade). Turn blades **OFF** when traveling uphill. Use a slow speed and avoid sudden or sharp turns.
3. **DO NOT** operate machine back and forth across face of slopes. Operate up and down. Practice on slopes with blades off.

PROTECTION AGAINST TIPOVERS

(Continued From Previous Column)

4. **AVOID** starting, stopping or turning on slopes. If machine stops going uphill or tires lose traction, turn blades **OFF** and back slowly straight down the slope.
5. **STAY ALERT** for holes and other hidden hazards. Tall grass can hide obstacles. Keep away from ditches, washouts, culverts, fences and protruding objects.
6. **DO NOT** operate machine near drop offs, ditches, embankments, washouts, culverts, fences and protruding objects. **KEEP A SAFE DISTANCE** (at least 3 feet) away from edge of ditches and other drop offs. The machine could turn over if an edge caves in.
7. Always begin forward motion slowly and with caution.
8. Use weights or a weighted load carrier in accordance with instructions supplied with a grass catcher. **DO NOT** operate machine on slopes exceeding 10 degrees (18% grade) when equipped with grass catcher.
9. **DO NOT** put your foot on the ground to try to stabilize the machine.
10. **DO NOT** operate machine on wet grass. Reduced traction could cause sliding.
11. Chose a low enough ground speed setting so that you will not have to stop or shift on a slope. Tires may lose traction on slopes even though the brakes are functioning properly.
12. **DO NOT** operate machine under any condition where traction, steering or stability is doubtful.
13. Always keep machine in gear when going down slopes. **DO NOT** shift to neutral (or actuate hydro roll release) and coast downhill.
14. Operator Protective Structures are available for this machine through your local SNAPPER dealer.

PREPARATION

1. Read, understand and follow instructions and warnings in this manual and on the machine, engine and attachments. Know the controls, the safety signs and the proper use of the machine before starting. If the operators or mechanics cannot read English, it is the owner's responsibility to explain this material to them.



IMPORTANT SAFETY INSTRUCTIONS



PREPARATION

(Continued From Previous Page)

2. Only mature, responsible persons shall operate or service the machine and only after proper instruction and training. The owner is responsible for training the operators. Further, the owner/operator can prevent and/or is responsible for accidents or injuries occurring to themselves, other people or property.
3. Data indicates that operators age 60 and above, are involved in a large percentage of mower-related injuries. These operators should evaluate their ability to operate the mower safely enough to protect themselves and others from serious injury.
4. Handle fuel with extra care. Fuels are flammable and vapors are explosive. Use only an approved fuel container. DO NOT remove fuel cap or add fuel with engine running. Add or drain fuel outdoors only with engine stopped and cool. Clean spilled fuel from machine. DO NOT smoke.
5. Practice operation of machine with **BLADES OFF** to learn controls and develop skills.
6. Check the area to be mowed and remove all objects such as toys, wire, rocks, limbs and other objects that could cause injury if thrown by blades or interfere with mowing.
7. Evaluate the terrain to determine what accessories and attachments are needed to properly and safely perform the job. Only use accessories and attachments approved by SNAPPER.
8. Keep people and pets out of mowing area. Immediately, **STOP** blades, **STOP** engine, and **STOP** machine if anyone enters the area.
9. DO NOT operate machine unless all shields, deflectors, switches, blade controls and other safety devices are in place and functioning properly.
10. Make sure all safety decals are clearly legible. Replace if damaged.
11. Protect yourself when mowing and wear appropriate clothing including safety glasses, long pants, ear protection, hardhat and substantial footwear with good traction. Long hair, loose clothing or jewelry may get tangled in moving parts.
12. Know how to **STOP** blades and engine quickly in preparation for emergencies.
13. Use extra care when loading or unloading the machine into a trailer or truck.
14. Check grass catcher components frequently for signs of wear or deterioration and replace as needed to prevent injury from thrown objects going through weak or worn spots.

SAFE HANDLING OF GASOLINE

To avoid personal injury or property damage, use extreme care in handling gasoline. Gasoline is extremely flammable and the vapors are explosive

1. Extinguish all cigarettes, cigars, pipes and other sources of ignition.
2. Use only an approved fuel container.
3. DO NOT remove fuel cap or add fuel with the engine running. Allow the engine to cool before refueling.
4. DO NOT refuel the machine indoors.
5. DO NOT store the machine or fuel container inside where there is an open flame, spark or pilot light such as on a water heater or other appliances.
6. DO NOT fill fuel containers inside a vehicle or on a truck or trailer bed with a plastic liner. Always place the containers on the ground away from the vehicle before filling.
7. Remove gas-powered equipment from the vehicle or trailer and refuel it on the ground. If this is not possible, then refuel equipment using a portable container, rather than a gasoline dispenser nozzle.
8. DO NOT start gas powered equipment in enclosed vehicles or trailers.
9. Keep the nozzle in contact with the rim of the fuel tank or container opening at all times until fueling is complete. DO NOT use a nozzle lock-open device
10. If fuel is spilled on clothing, change clothing immediately.
11. DO NOT overfill a fuel tank. Replace fuel cap and tighten securely.

OPERATION

1. Mount and dismount machine from left side.
2. Start engine from operator's seat. Make sure blades are OFF and parking brake is set. Use seat belts if provided.
3. DO NOT leave machine with engine running. Stop engine. Stop blades. Set brake. Remove key.
4. DO NOT operate machine unless properly seated with feet on foot rests or pedal(s).
5. DO NOT operate machine while under the influence of alcohol or drugs.
6. **STOP MACHINE** on level ground, lower deck, engage parking brake and make sure engine and blades have stopped before removing grass catcher or unclogging mower to prevent injury to hands or feet.
7. Blades must be OFF except when cutting grass. Set blades in highest position when mowing over rough ground.



IMPORTANT SAFETY INSTRUCTIONS



OPERATION

(Continued From Previous Page)

8. Keep hands and feet away from rotating blades underneath deck. **DO NOT** place foot on ground while **BLADES** are **ON** or machine is in motion.
9. **DO NOT** operate machine without entire grass catcher or guards in place. **DO NOT** point discharge at people, passing cars, windows or doors.
10. Slow down before turning.
11. Watch out for traffic when near or crossing roadways.
12. **STOP** engine immediately after striking an object or if an abnormal vibration occurs. Remove key. Remove and disconnect the sparkplug wire. Make necessary repairs before resuming operation.
13. Mow only in daylight or with good artificial light.
14. Move motion control levers **SLOWLY** to maintain control during speed and directional changes.
15. Exercise **CAUTION** when pulling loads. **DO NOT** pull loads greater than 300 pounds. Avoid jack knifing. **DO NOT** turn sharply. Attach loads to approved hitch point only following manufacturer's instructions.
16. On slopes, the weight of towed equipment may cause loss of traction and loss of control. When towing travel slowly and allow extra distance to stop.
17. **DO NOT** operate engine in enclosed areas. Engine exhaust gases contain carbon monoxide, an odorless and deadly poison.

MAINTENANCE

1. **DO NOT** store machine or fuel container inside where fumes may reach an open flame, spark or pilot light such as in a water heater, furnace, clothes dryer or other gas appliance. Allow engine to cool before storing machine in an enclosure. Store fuel container out of the reach of children in a well ventilated, unoccupied building. Shut off fuel (when equipped with valve) while storing or transporting machine.
2. Clean grass and debris from engine, mufflers, drives and cutting units to help prevent overheating and fires. Clean up fuel, oil and excess grease.
3. When draining fuel tank, drain fuel into an approved container outdoors and away from open flame.
4. Check brakes frequently; adjust, repair or replace as needed.
5. Keep all bolts, nuts and screws properly tight. Check that all cotter pins are in proper position.

MAINTENANCE

(Continued From Previous Column)

6. Always provide adequate ventilation when running engine. Engine exhaust gases contain carbon monoxide, an odorless and deadly poison.
7. Disconnect battery before performing maintenance or service. Cranking engine could cause injury. Disconnect negative (black) cable from battery first and positive (red) cable last. Reconnect positive first and negative last. Charge battery in an open, well ventilated area away from spark and flames. Unplug charger before connecting or disconnecting from battery. Wear protective clothing and insulated gloves.
8. Park machine on level ground. **DO NOT** work under machine without safety blocks.
9. Service engine and clean, adjust or repair only when engine and blades are stopped. Remove spark plug wire(s) from spark plug(s) and secure wire(s) away from spark plug(s).
10. **DO NOT** change engine governor speed settings or overspeed engine. **DO NOT** make adjustments with the engine running.
11. Lubricate machine at intervals specified in manual to prevent controls from binding.
12. Mower blades are sharp and can cut. Wrap the blades or wear heavy leather gloves and use **CAUTION** when handling them. Never straighten or weld blades, only replace them.
13. **DO NOT** test for spark by grounding spark plug next to spark plug hole; spark plug could ignite gas exiting engine.
14. Carefully release pressure from components with stored energy.
15. Have machine serviced by an authorized **SNAPPER** dealer at least once a year and have the dealer install any new safety devices. Never allow untrained personnel to service machine.
16. Use only genuine **SNAPPER** replacement parts to assure that original standards are maintained.

TABLE OF CONTENTS

IMPORTANT SAFETY INSTRUCTIONS	2-4
TABLE OF CONTENTS	5
SECTION 1 - FAMILIARIZATION	6
SECTION 2 –SAFETY MESSAGES AND SYMBOLS.....	7-8
SECTION 3 - OPERATING INSTRUCTIONS	9-13
Pre-start Checklist.....	9-10
Starting & Stopping Engine, Blades & Parking Brake.....	10-11
Starting & Stopping Mower Blades	11
Parking Brake	11
Cutting Height Adjustment	12
Driving & Stopping Machine.....	12-13
Safety Interlock System Check	13
SECTION 4 - MAINTENANCE INSTRUCTIONS	14-18
Change Engine Oil.....	14
Check Mower Blade	14
Check Mower Drive Belt	15
Check Belt Tension	15
Service – After every 25 Hours (Engine Components).....	15
Service – After every 25 Hours (Mower Components)	15
Lubrication	15
Mower Blade Spindle Lubrication.....	15
Mower Deck Linkage Lubrication	15
Front Wheel Bearings Lubrication.....	16
Hydro Pump Lubrication.....	16
Other Lubrication.....	16
Before Operating Machine.....	16
Annually - End of Season	16-17
Engine Service.....	16
Fuel Filter Replacement.....	17
Deck Removal.....	17-18
Hydraulic Fluid Filters.....	18
SECTION 5 - ADJUSTMENTS AND REPAIR	19-27
Neutral Position Adjustments	19-20
Mower Deck Adjustment (Levelness).....	20-21
Parking Brake Adjustment	21
Traction Belt Tension & Replacement.....	22
Blade Brake/Electric Clutch Adjustment	22
Tracking Adjustment.....	23
Mower Drive Belt Removal & Replacement	23
Engine Adjustments & Repair	24
Mower Blade Replacement.....	24
Mower Blade Sharpening	24
Battery Removal	25
Battery Installation	25
Battery Charging	25
Battery Testing	26
New Battery Preparation.....	26
Mower Spindle Bearing Replacement	27
Hydraulic System, Purging.....	28
TROUBLESHOOTING	29-30
SERVICE SCHEDULE	31
Maintenance/Replacement Parts	31
WARRANTY	32
PRIMARY MAINTENANCE.....	33-36
PRODUCT REGISTRATION FORM	37

IMPORTANT

NOTICE: Operator Protective Structures are available as optional kits for the Mid-Mount and Out-Front Z-Rider machines. These structures, when installed and used properly can offer additional security to the operator against serious injury in the event of a tip over accident. Operator Protective Structures may be required by local ordinances. Discuss your mowing application and ordinances with your local Snapper Dealer.

Section 1 - FAMILIARIZATION

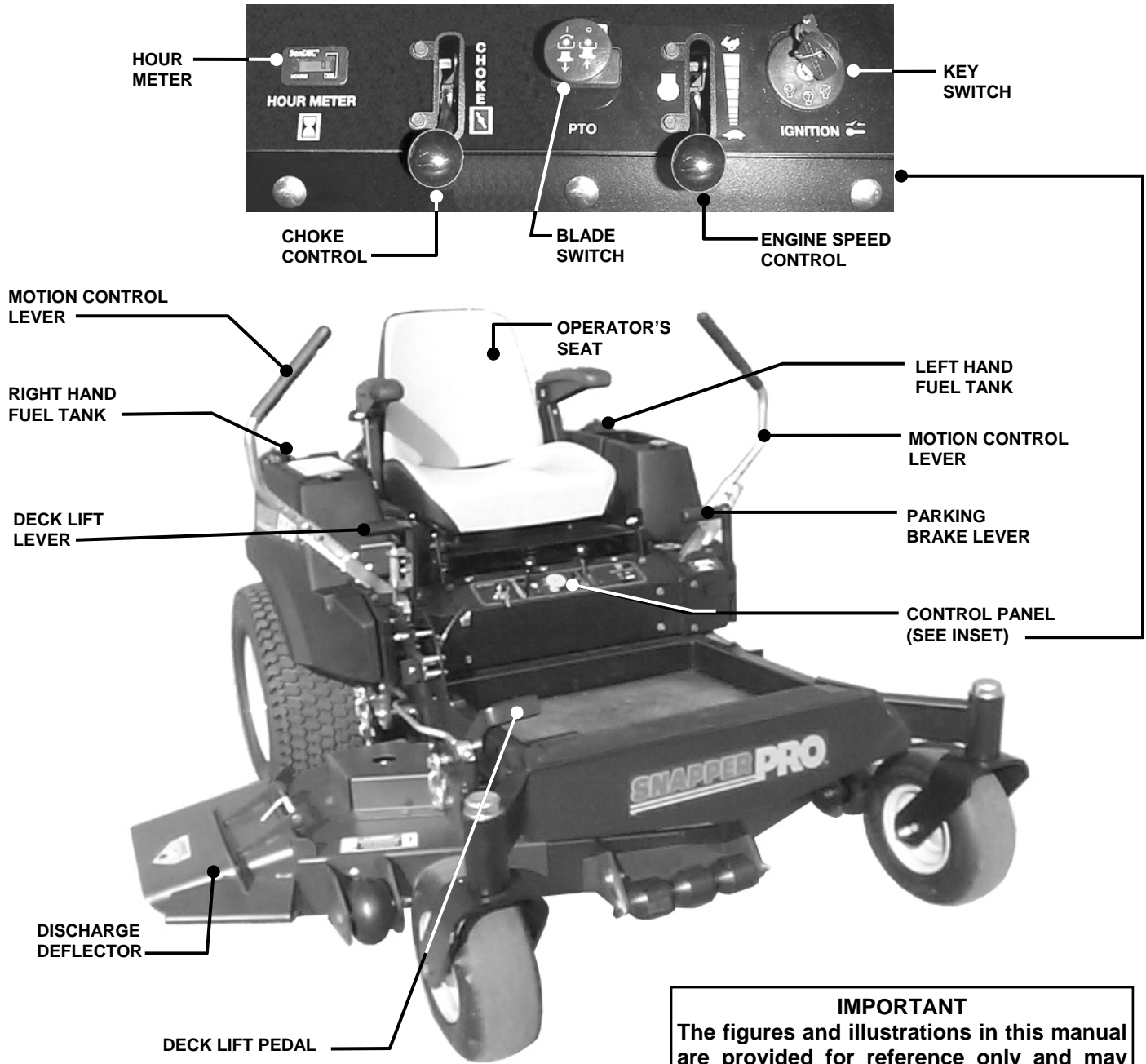

FIGURE 1.1

IMPORTANT

The figures and illustrations in this manual are provided for reference only and may differ from your specific model. Contact your Snapper dealer if you have questions

1.1 INTRODUCTION

This manual has been prepared for the operator's of the SNAPPER MID MOUNT Z-RIDER. Its purpose, aside from recommending standard operating procedures and routine service requirements, is to promote SAFETY through the use of accepted operating practices. Read, Understand and Follow the IMPORTANT SAFETY INSTRUCTIONS on Pages 2 thru 4 of this manual and All SAFETY messages on the MID MOUNT Z-RIDER and its attachments before operating. SNAPPER recommends returning the MID MOUNT Z-RIDER to an authorized SNAPPER dealer annually for inspection and addition of any new devices which might upgrade the safety of the mower.

1.2 NOMENCLATURE

The nomenclature information above, Figure 1.1, shows the essential parts of the SNAPPER MID MOUNT Z-RIDER. It is recommended that all operators of this equipment become thoroughly familiar with the controls, components, and operation of this machine before operating. Specific details involving the engine are found in the separate engine owner's manual. Study these manuals before operating and keep both handy for future reference. For the nearest SNAPPER dealer in your area, check the yellow pages under the heading LAWN MOWERS. For engine parts and service, look for the engine manufacturer's dealers under the heading, ENGINES - gasoline.

Section 2 – SAFETY MESSAGES AND SYMBOLS



**DANGER ! ROTATING PARTS
KEEP AWAY FROM MOVING PARTS**

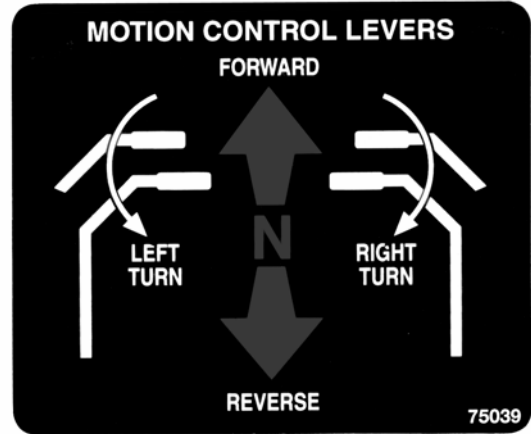

MOTION CONTROL LEVER OPERATION



PARKING BRAKE LEVER OPERATION



WEAR HEARING PROTECTION

TO START:
MAKE SURE OPERATOR IS SEATED PROPERLY. • PLACE MOTION CONTROL LEVERS IN CENTER/NEUTRAL POSITION. • PULL UP ON BRAKE LEVER TO SET BRAKE. • PUSH BLADE SWITCH DOWN TO MAKE SURE BLADE IS DISENGAGED. • SET CHOKE AND THROTTLE. • TURN KEY TO START ENGINE.

TO OPERATE:
ADJUST CHOKE AND THROTTLE. • PULL BLADE SWITCH UP TO ENGAGE BLADE. • PUSH PARKING BRAKE LEVER DOWN TO RELEASE BRAKE. • MOVE MOTION CONTROL LEVERS IN THE DIRECTION OF TRAVEL REQUIRED. • INCREASE / DECREASE SPEED WITH AMOUNT OF MOTION CONTROL LEVERS TRAVEL FROM CENTER / NEUTRAL POSITION.

TO STOP:
MOVE MOTION CONTROL LEVERS TO CENTER / NEUTRAL POSITION. • PUSH BLADE SWITCH DOWN TO DISENGAGE BLADE. • PULL UP ON BRAKE LEVER TO SET BRAKE. • TURN KEY TO OFF POSITION AND REMOVE. • MAKE SURE ALL MOVEMENT HAS STOPPED BEFORE DISMOUNTING.

! WARNING

TO AVOID SERIOUS INJURY OR DEATH

- READ OPERATOR'S MANUAL AND OTHER INSTRUCTIONAL MATERIALS PROVIDED.
- KNOW LOCATION AND FUNCTION OF ALL CONTROLS.
- THIS MACHINE IS DESIGNED FOR PROFESSIONAL USERS. DO NOT OPERATE UNTIL THOROUGHLY TRAINED AND FAMILIAR WITH ALL CONTROLS AND PROPER USE OF THIS MACHINE.
- NEVER START BLADES UNLESS PROPERLY SEATED ON MACHINE.
- KEEP SAFETY DEVICES (GUARDS, SHIELDS AND SWITCHES) IN PLACE.
- REMOVE OBJECTS THAT COULD BE THROWN BY THE BLADES.
- DO NOT MOVE MOTION CONTROL LEVERS RAPIDLY. AVOID SUDDEN TURNS.
- DO NOT OPERATE BLADES IN REVERSE.
- LOOK DOWN AND BEHIND BEFORE AND DURING REVERSE MOVEMENT.
- DO NOT MOW IN ANY AREA WHERE STABILITY AND TRACTION IS IN DOUBT. DO NOT MOW ON SLOPES STEEPER THAN 15°.
- REDUCE SPEED ON SLOPES. GO FORWARD DOWN SLOPES. GO REVERSE UP SLOPES, NEVER TRAVEL ACROSS SLOPES.
- AVOID UPHILL STARTS. IF MACHINE STOPS GOING UPHILL, STOP BLADES AND BACK DOWN SLOWLY.
- DO NOT MOW WHEN CHILDREN OR OTHERS ARE AROUND. NEVER CARRY CHILDREN DURING OPERATION EVEN WITH BLADES OFF.
- BE SURE ALL MOVING PARTS ARE STATIONARY BEFORE PLACING HANDS AND FEET NEAR BLADES OR SERVICING MACHINE.

**WARNING ! AVOID SERIOUS INJURY OR DEATH
STARTING, OPERATION & STOPPING OF MACHINE**

Section 2 – SAFETY MESSAGES AND SYMBOLS

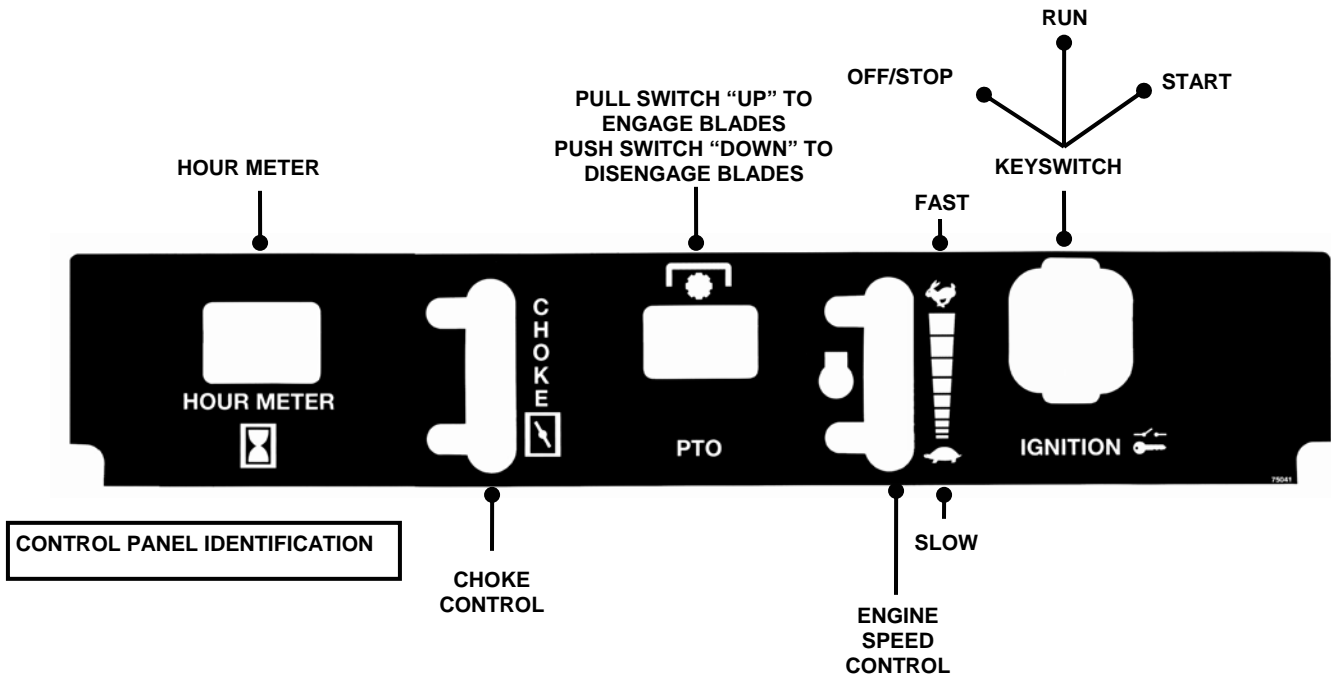

DANGER! ROTATING BLADES
 KEEP CHILDREN AND OTHERS OUT OF MOWING AREA



Section 3 - OPERATING INSTRUCTIONS

3.1 PRE-START CHECK LIST

Make the following checks and perform the service required before each start-up.

3.1.1. Check tires and add or release air as needed to bring pressure to 12 psi in drive tires. Pressure in front caster wheels should be 25 psi.

3.1.2. Check guards, deflectors and covers to make sure all are in place and securely tightened.

3.1.3. Check engine oil and add oil as needed to bring level up to the FULL mark. Refer to engine owner's manual for oil specifications. See Figure 3.1.

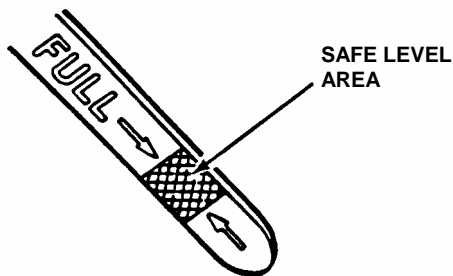

FIGURE 3.1

3.1.4. Check Blade Switch to insure it works freely.

1. Pull the Blade Switch up to the "ON" position to engage or turn "ON" the mower blades.

2. Push Blade Switch down to the "OFF" position to disengage (or turn "OFF") the blades.



BLADE SWITCH
FIGURE 3.2

3.1.5. Clean exterior surfaces of cutting deck, engine and pumps of any accumulation of dirt, grass, oil, etc. Keep engine and pump air intake screens and cooling fins clear at all times.

3.1.6. Add fuel to both tanks of the machine outside where fumes can safely dissipate. Make sure both fuel filler caps are tight. Note the fuel tank selector valve. Refer to engine owner's manual for fuel specifications.

3.1.7. Adjust position of operator's seat. The seat is mounted on slides. Locate latch lever beneath the seat. Move lever towards the left and slide seat to the desired position. Release latch. If equipped, adjust seat suspension for operator weight.

3.1.8. Place mower in desired cutting height setting. Grasp deck lift lever and depress release latch located underneath the lever. Move lever to desired cutting height setting and release latch. Insert stop pin to desired cutting height.

IMPORTANT: There is a foot assist pedal located to the right front side of the footrest. Always use this assist pedal to raise or lower the deck to the desired cutting height. See Figure 3.3.

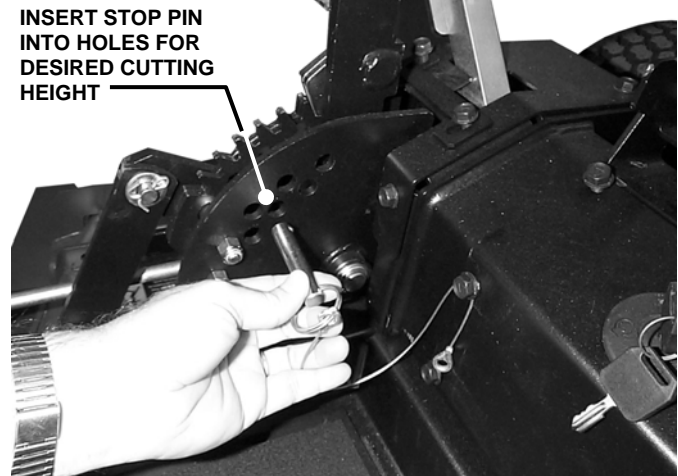
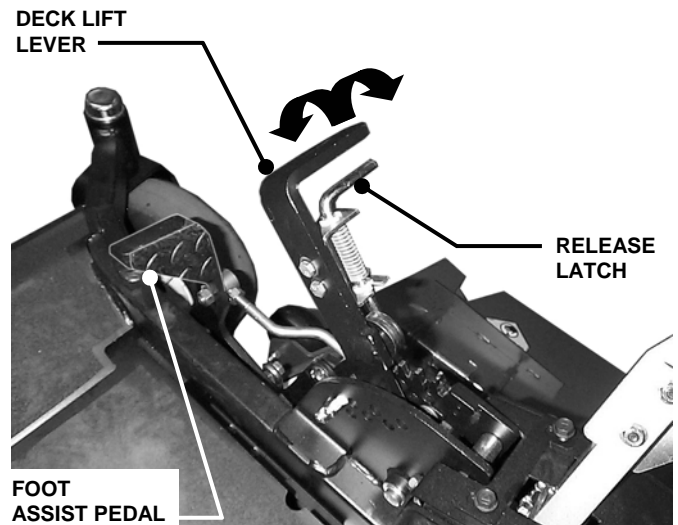

FIGURE 3.3

IMPORTANT: This machine is equipped with hydrostatic drive. The direction of motion and the speed of motion are controlled by the left and right motion control levers. A small movement of these controls can cause the machine to move instantly. **DO NOT** attempt to operate the machine until you read this manual and become familiar with its operation. Practice with the blades "OFF" disengaged, engine speed at a slow setting and in an open area away from obstacles.

	WARNING	
DO NOT allow operation of the machine by untrained personnel.		

Section 3 - OPERATING INSTRUCTIONS

ROLL RELEASE: To roll the machine without the engine running, pressure within the hydraulic pumps must be released. There is a hydraulic pressure relief valve on the upper side of each pump that is used to release the pressure. Use a wrench to rotate both relief valves counter clockwise two full turns to open. After rolling machine, both relief valves must be rotated clockwise to close valves and tighten securely before operating machine. Machine will not move if relief valves are open. See Figure 3.4.

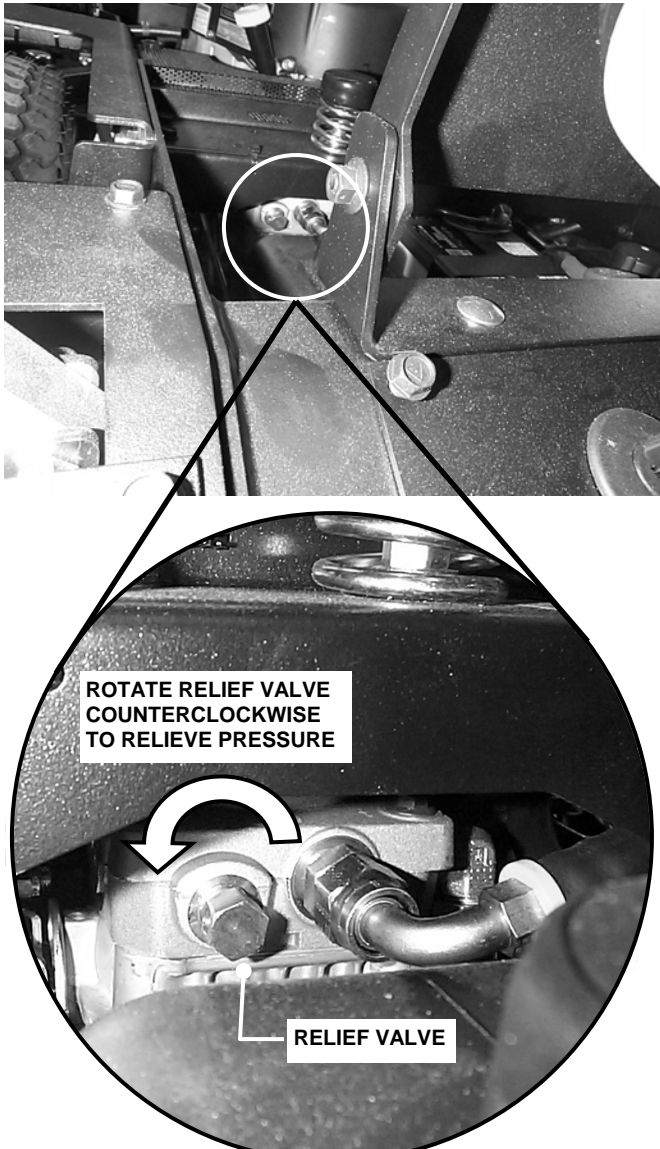

FIGURE 3.4

3.2 STARTING & STOPPING – ENGINE, BLADES, PARKING BRAKE

This machine is equipped with dual hydrostatic wheel drive transmissions. Each hydro pump is controlled by a separate motion control lever. The left lever controls the left wheel drive hydro pump and the right lever controls the right wheel drive hydro pump. These levers control the direction of motion, Forward & Reverse, and the speed of motion. Move both levers forward to propel the machine forward. Move both levers rearward to propel the machine in reverse. The speed of motion is continuously variable from neutral (zero) to the maximum. Moving the levers farther from the neutral position will cause the speed of motion to increase. To turn, move the lever on the side to which you want to turn slightly rearward of the other lever. Move levers slowly and carefully. DO NOT make sudden changes in speed or direction. Always slow machine motion before turning. To stop the motion of the machine, bring both motion control levers to the neutral position. Engage parking brake.

3.2.1. STARTING ENGINE

When the ignition key is turned the engine will not start or turn over unless, the blade switch is pushed in to the "OFF" position and the motion control levers are in the neutral lock position. Always engage parking brake before starting engine.

1. Complete pre-start checklist.
2. Sit in operator's seat.
3. Push blade switch in to "OFF", blades disengaged position and engage parking brake. See Figure 3.2.
4. Move choke control forward to choke position to start a cold engine. See Figure 3.5.
5. Move engine speed control to the Rabbit "FAST" position. See Figure 3.5.
6. Turn key to the start position until engine starts. See Figure 3.6.

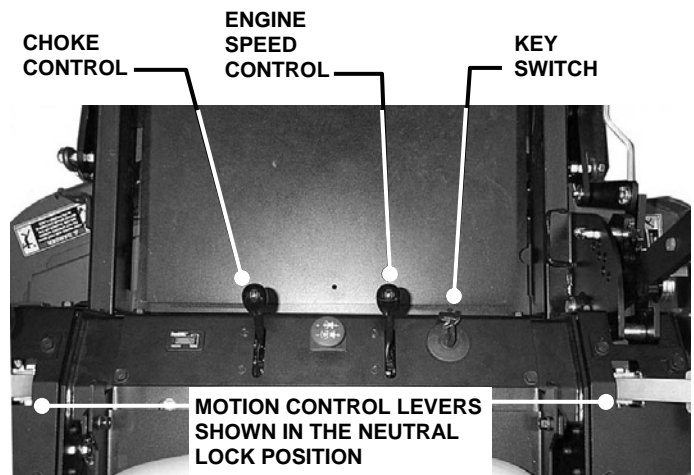

SHOWN FROM OPERATOR'S VIEW POINT

FIGURE 3.5

WARNING
DO NOT disengage the hydro transmission and coast down slopes. DO NOT use Roll Release Control to disengage the hydro transmission unless machine motion can be controlled and engine is off.

Section 3 - OPERATING INSTRUCTIONS

3.2.1. STARTING ENGINE

NOTE: If after 5 seconds of cranking the engine does not start, release the key. Attempt starting again after waiting for approximately 20 seconds.

7. After engine starts, move the choke control to the "OFF" or no choke position. Allow a brief warm-up until engine runs smooth.

3.2.2. STOPPING ENGINE

1. Stop engine by turning key to "STOP" position. Move engine speed to the Turtle "SLOW" position and turn key to "STOP". See Figure 3.6.

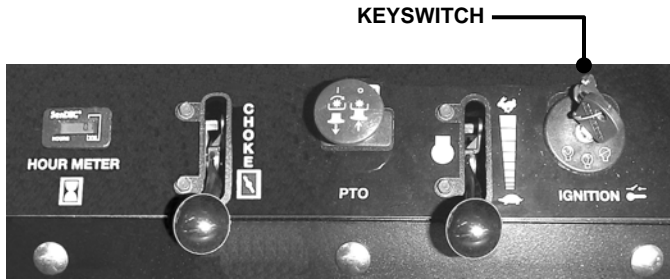

SHOWN FROM OPERATOR'S VIEW POINT

FIGURE 3.6

3.2.5. PARKING BRAKE

1. Engage parking brake by pulling the parking brake lever back to the engaged position. See Figure 3.7.

NOTE: Engaging parking brake prior to placing motion control levers in the neutral lock position will cause engine to die. See Figure 3.7.

2. Release parking brake by pushing parking brake lever forward to the released position. See Figure 3.8.



MOTION CONTROL LEVER

LEVER SHOWN IN THE NEUTRAL LOCK POSITION



FIGURE 3.7

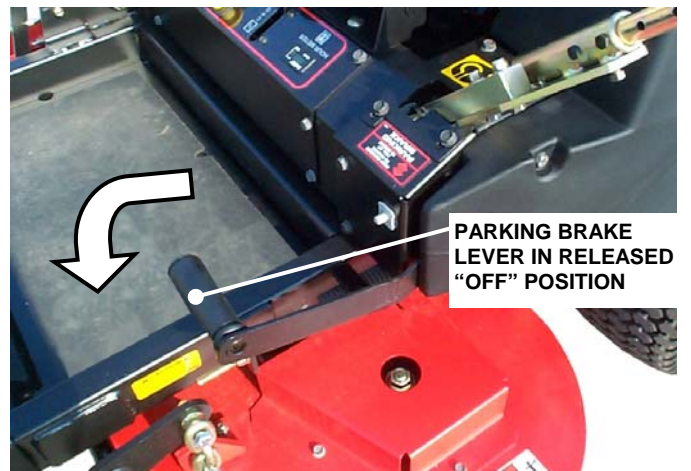

FIGURE 3.8

WARNING
DO NOT operate blades in reverse. STOP blades. LOOK and SEE behind and down for children, pets, and hazards before and while backing.

3.2.3. STARTING MOWER BLADES

1. Start engine and set engine speed control to the Rabbit "FAST" position. See Figure 3.5.

2. Pull the Blade Switch up to the "ON" position to engage or turn "ON" the mower blades. See Figure 3.2.

3.2.4. STOPPING MOWER BLADES

1. Push Blade Switch down to "OFF" position to disengage or turn "OFF" the blades.

2. Move engine speed control to the Turtle "SLOW" position. Turn key to "STOP" position.

WARNING
Once blades are disengaged, they should come to a complete stop in 7 seconds. If the blades continue to rotate after 7 seconds, the electric clutch should be checked. Adjustment or replacement of electric clutch may be necessary. Return the machine to an authorized Snapper dealer for replacement. DO NOT CONTINUE to operate mower if blades fail to stop in 7 seconds.

WARNING
DO NOT park the machine on slopes. DO NOT leave machine with engine running. Stop engine. Stop blades. Engage parking brake. Remove key.

Section 3 - OPERATING INSTRUCTIONS

3.3 CUTTING HEIGHT ADJUSTMENT

1. Adjust cutting height, as desired, to any position, using deck lift lever. The release latch should be pulled up when lowering the deck. When raising the deck, the release latch does not have to be pulled up. **IMPORTANT:** There is a foot assist pedal located to the right front side of the footrest. Always use this assist pedal to raise or lower the deck to the desired cutting height. See Figure 3.9 & 3.10.
2. If a specific deck height is desired each time the machine is used, insert the stop pin to desired cutting height. See Figure 3.11.

NOTE: The engine does not have to be running to adjust cutting height.

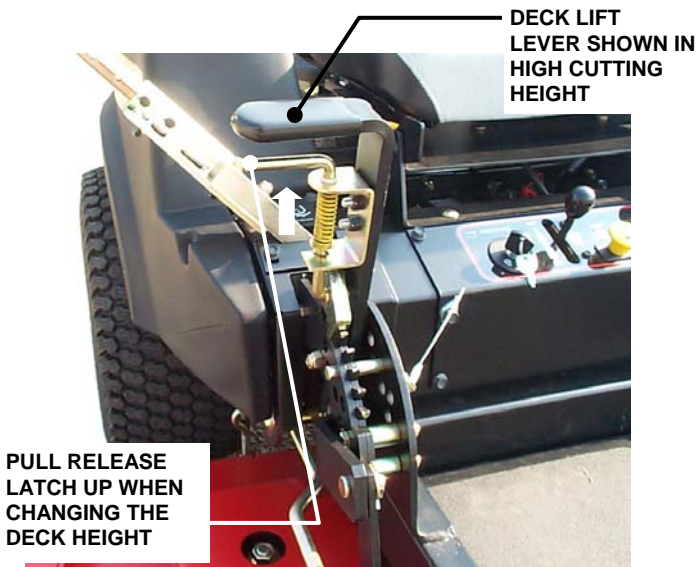

FIGURE 3.9

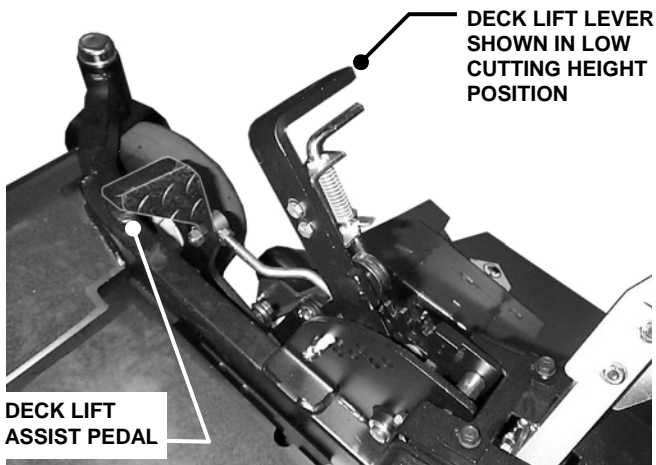

FIGURE 3.10

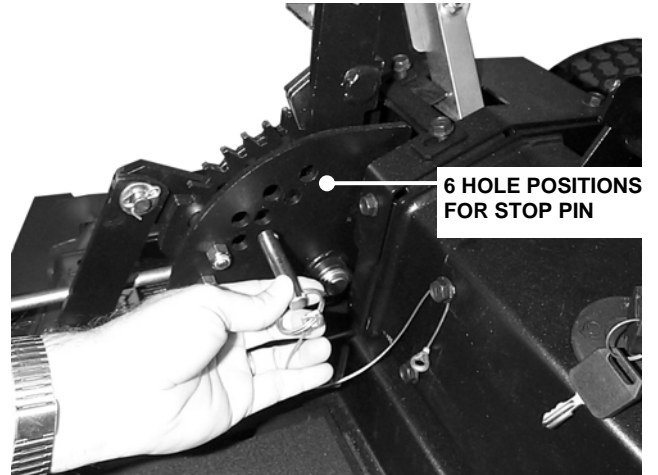

FIGURE 3.11

3.4 OPERATION- MOTION CONTROLS

3.4.1. DRIVING MACHINE

1. Start engine. Release parking brake.
2. Move motion control levers gently and with caution in desired direction. See Figure 3.12.
 - FORWARD** - Move both control levers forward.
 - REVERSE** - Move both control levers rearward.
 - LEFT TURN** - Move left control rearward or move right control lever forward.
 - RIGHT TURN** - Move left control forward or move right control lever rearward.
 - ZERO RADIUS TURN** - Move one control lever forward and move the other control lever rearward simultaneously.

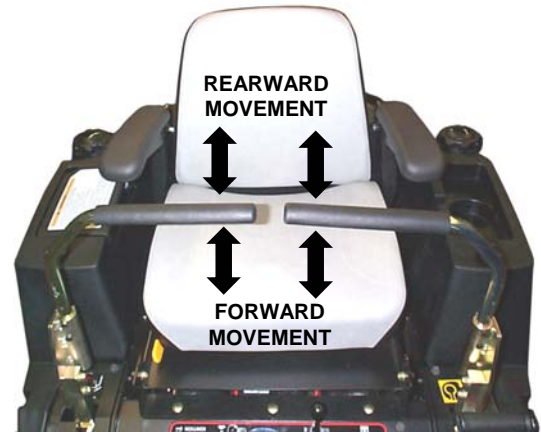

FIGURE 3.12

WARNING

DO NOT make turns at high speed. Slow machine motion. Move motion control lever gently and with caution. DO NOT make sudden changes in speed or direction.

WARNING

Zero-turning the machine at any speed can result in operator disorientation, or in operator being thrown from the machine. Exercise extreme caution when executing a zero-turn.

Section 3 - OPERATING INSTRUCTIONS

3.4.2. STOPPING MACHINE

1. Return motion control lever to the neutral position & the neutral lock position.

IMPORTANT: Operator must use hand assistance to bring both motion control levers to the neutral position & the neutral lock position.

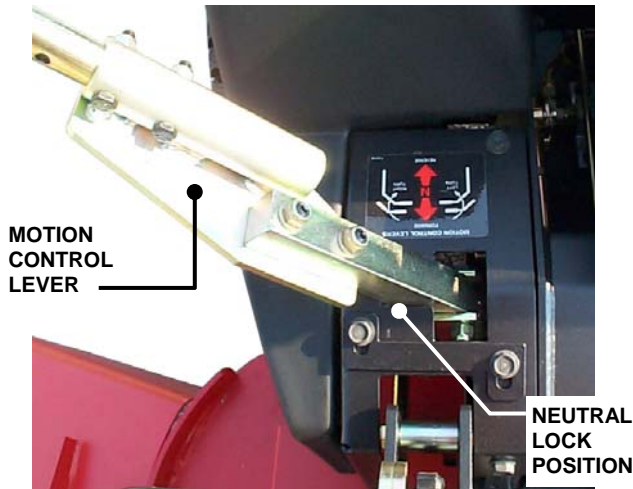

FIGURE 3.13

2. Engage parking brake.
3. Push Blade Switch down to the "OFF" position to disengage or turn "OFF" the blades.
4. Stop engine. Move engine speed control to turtle "SLOW" position. Turn key to stop position.
5. Remove key.

3.5 SAFETY INTERLOCK SYSTEM CHECKS

This machine is equipped with an electrical safety interlock system that is provided for the safety of the operator and others. All safety devices must be in place and functioning properly before operating the machine. Perform the following interlock system checks periodically during the operating season. Contact your authorized Snapper dealer if you have questions.

WARNING
DO NOT operate machine if any safety interlock or safety device is not in place and functioning properly. DO NOT attempt to defeat, modify or remove any safety device.

ENGINE MUST NOT START IF:

1. Motion Control Lever(s) are not in the neutral lock position OR,
2. Parking Brake disengaged and Operator not seated in the Operator's Seat OR,
3. Blade Switch in the "ON" blades engaged position.

ENGINE SHOULD START IF:

1. Blade Switch in the "OFF" blades disengaged position AND,
2. Motion Control Levers are both in the neutral lock position AND,
3. Operator properly seated in the Operator's Seat OR,
4. Parking Brake engaged.

NOTE: The engine can be started with the parking brake disengaged only if conditions in 1, 2 and 3 have been met.

ENGINE MUST BEGIN TO STOP IF:

1. Motion Control Levers are moved from the neutral lock position with Parking Brake engaged OR,
2. Operator rises off of seat with Blade Switch in "ON" blades engaged position OR,
3. Operator rises off of seat with Parking Brake disengaged.

IMPORTANT: Engine and blades will continue to run if Operator becomes reseated prior to engine coming to a complete stop. After coming to a complete stop, the blade switch must be moved to the "OFF" position before engine can be restarted. Engine and blades must come to a complete stop within 7 seconds after the operator rises off the seat or the blade switch is moved to the "OFF" position.

WARNING
DO NOT park the machine on slopes. DO NOT leave machine with engine running. Stop engine. Stop blades. Engage parking brake. Remove key.

Section 4 - MAINTENANCE

4.1 INTRODUCTION

To retain the quality of the SNAPPER mower, use genuine SNAPPER replacement parts only. Contact a local SNAPPER dealer for parts and service assistance. For the correct part or information for a particular SNAPPER mower, always mention the model and serial number. SNAPPER recommends returning the mower to an authorized SNAPPER dealer annually for inspection and addition of any new devices, which might upgrade the safety of the mower. For the nearest SNAPPER dealer in your area, check the yellow pages under the heading LAWN MOWERS. For engine parts and service, look for the engine manufacturer's dealers under the heading, ENGINES - gasoline.

4.2 SERVICE - AFTER FIRST 5 HOURS

WARNING
DO NOT attempt any maintenance, adjustments or service with engine running. STOP engine. STOP blades. Set brake. Remove key. Remove spark plug wires and secure away from spark plugs. Engine and components are HOT. Avoid serious burns; allow sufficient time for all parts to cool.

4.2.1. CHANGE ENGINE OIL

Change engine oil as follows:

1. Place a 4 quart minimum capacity container under the end of the oil drain.
2. Rotate counter clockwise and pull out to open the drain plug. See Figure 4.1.

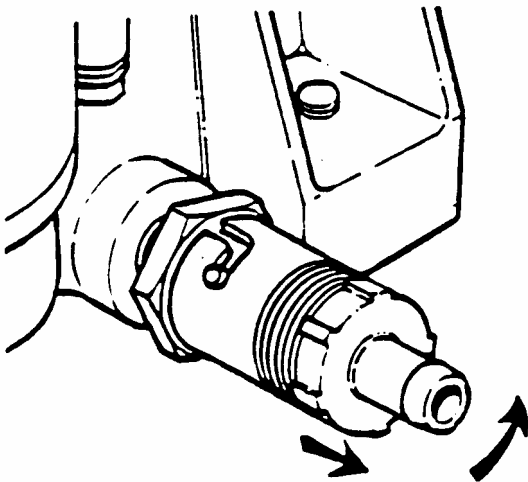

ROTATE PLUG COUNTER CLOCKWISE THEN PULL OUT TO DRAIN OIL

FIGURE 4.1

3. After all the oil has drained, close the drain by pushing in and rotating clockwise to close. Wipe up any oil that may have spilled. Dispose of drained oil properly. See Figure 4.1.

4. Fill engine crankcase with new oil. Refer to your engine owner's manual for oil specifications.

5. Change engine oil filter at every oil change. Refer to your engine owner's manual for service instructions.

4.2.2. CHECK MOWER BLADE

1. Stop Engine. Remove key. Disconnect spark plug wire(s) and secure away from spark plug(s).
2. Engage parking brake.
3. Use a hydraulic floor jack or hoist to raise machine high enough to gain access to the underside of deck. Secure machine with safety blocks.

WARNING
Wear heavy leather gloves when handling or working around cutting blades. Blades are extremely sharp and can cause severe injury. DO NOT use a cutting blade that shows signs of excessive wear or damage. Refer to Section "MOWER BLADE REPLACEMENT" for proper blade inspection and service procedures.

4. Check torque of blade mounting bolts. As necessary, torque to 70 to 80 ft. lbs. See Figure 4.2.
5. Check blade for sharpness, wear and damage. Refer to Section "BLADE WEAR LIMITS".
6. Check blade for straightness.

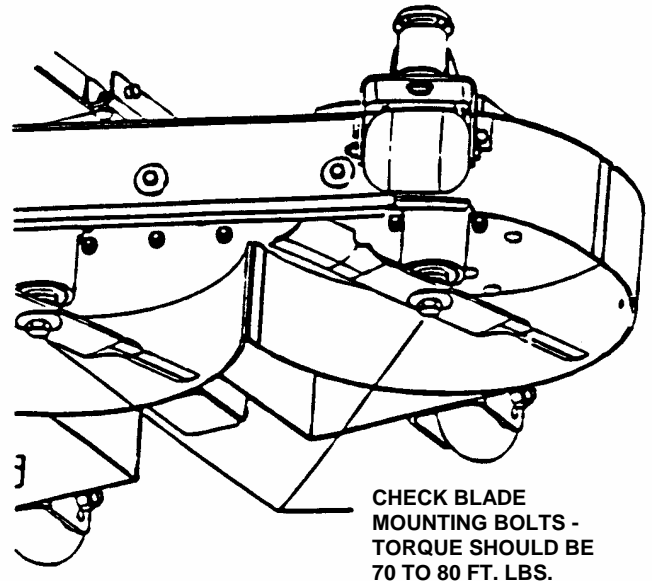

FIGURE 4.2

Section 4 - MAINTENANCE

4.2.3. CHECK MOWER DRIVE BELT

1. Lower deck to lowest setting.
2. Remove footrest. See Figure 4.3.
3. Removal of footrest will allow access to deck belt.
4. Check the belt tension. The idler pulleys and springs provide proper belt tension and require no adjustments. If belt is frayed, slit, severed or belt strands exposed, replace belt before operating mower.



LIFT FOOT REST UP AND OFF POWER UNIT FRAME TO GAIN ACCESS TO MOWER BELT

FIGURE 4.3

4.3 AFTER EVERY 25 OPERATING HOURS

4.3.1. ENGINE

1. Engine Oil

Change engine oil. Refer to Section "CHANGE ENGINE OIL". Refer to engine owner's manual for oil specifications.

2. Air Filter

Refer to engine owner's manual for service instructions.

4.3.2. MOWER COMPONENTS

1. Mower Drive Belt

No adjustment required. Replace belt as needed.

2. Mower Blade

Check blade for sharpness, wear, damage, and torque. Refer to Section "MOWER BLADE REPLACEMENT".

3. Mower Deck Levelness

Check mower deck for proper levelness. Adjust as required. Refer to Section "MOWER DECK ADJUSTMENT – LEVELNESS".

4. Clean Mower Deck

- a. Remove key from ignition switch.
- b. Remove spark plug wire(s) and secure away from spark plug(s).
- c. Raise mower deck to its highest setting. It may be necessary to raise mower deck higher using a hydraulic floor jack. Secure machine with safety blocks.
- d. Clean underside of mower deck, removing all accumulation of grass clippings and debris.
- e. Clean top of deck, removing all grass clippings and debris.

5. Mower Blade Spindle - Lubrication

- a. Remove footrest.
- b. Lubricate with Kendall NLGI No. 2 lithium grease or equivalent, from a grease gun until grease purges from vent located on spindle housing underneath deck. See Figure 4.4.

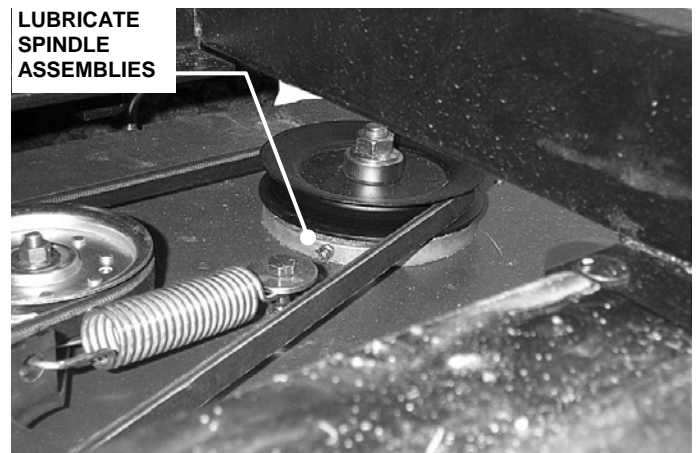

FIGURE 4.4

6. Mower Deck Linkage - Lubrication

Lubricate all mower deck linkage pivot points with a light coat of motor oil.

	WARNING	
DO NOT attempt any maintenance, adjustments or service with engine running. STOP engine. STOP blades. Set brake. Remove key. Remove spark plug wires and secure away from spark plugs. Engine and components are HOT. Avoid serious burns, allow sufficient time for all parts to cool.		

Section 4 - MAINTENANCE

4.3.3. RIDING MOWER - LUBRICATION

1. Front Wheel Bearings

Lubricate with Kendall NLGI No. 2 lithium grease or equivalent, from a grease gun. See Figure 4.5.

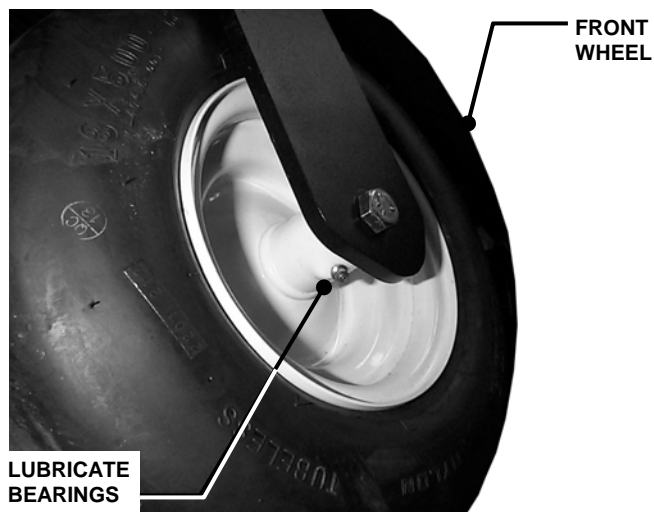

FIGURE 4.5

2. Hydro Pumps

Check the level of the fluid in both of the fluid reservoirs. Wipe away all dirt and debris from around reservoir cap before removing. Oil must remain absolutely clean! Check with machine on a level surface with engine "OFF". Fill reservoir as needed to bring level up. The reservoir is properly filled when the fluid level is 1½" below the top of the filler neck. **DO NOT OVER FILL.** Use clean, fresh premium automotive oil having a viscosity equivalent to SAE 20W50 API SL. The fluid should be chemically stable, incorporating rust and oxidation inhibitors. Make sure funnels, pouring spouts and oil can are completely clean. Reinstall reservoir cap. See Figure 4.6.

3. Other Lubrication Points

Lubricate machine caster wheel shafts and mower deck idler arms with Kendall NLGI No. 2 lithium grease or equivalent, from a grease gun. See Figure 4.7.

4.4 BEFORE OPERATING MACHINE

1. Clean all dirt and debris from around the two hydraulic fluid reservoirs. Especially around the top and cap area.
2. Clean all dirt and debris from the cooling fins on the engine and from both hydraulic pumps.

4.5 ANNUALLY (END OF EACH SEASON)

Perform all maintenance as described in Section "AFTER EVERY 25 OPERATING HOURS". Refer to Section "Service Schedule".

4.5.1. ENGINE

Service engine according to engine owner's manual.

HYDRAULIC FLUID RESERVOIRS

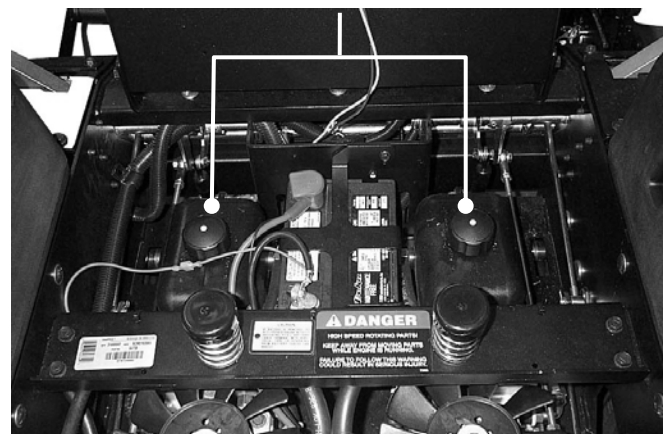

FIGURE 4.6

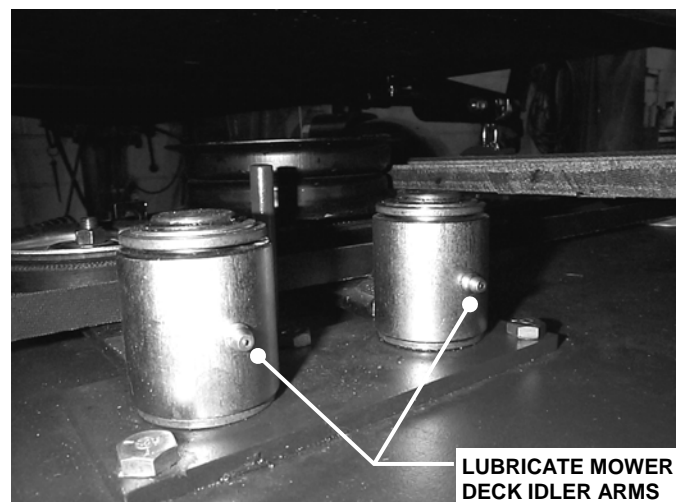

FIGURE 4.7

(Continued on next Page)

Section 4 - MAINTENANCE

WARNING

Allow engine to cool for at least ten minutes before performing service or maintenance. **DO NOT** smoke near fuel components when performing service or maintenance. **DO NOT** perform service and maintenance near an open flame. Wipe off any spilled fuel before starting engine. **DO NOT** run engine indoors.

4.5 ANNUALLY (END OF EACH SEASON) (Continued from previous Page)

4.5.2. FUEL FILTER

Service fuel filter as instructed below. Turn key to "OFF" position. Engine **MUST** be stopped and **MUST** be cold before removing filter. Clamp fuel line to prevent fuel spillage or perform filter change when fuel tank and fuel line are empty.

1. Remove fuel line clamps from fuel filter.
2. Remove fuel lines from filter. Discard filter.
3. Install new fuel filter. **IMPORTANT:** Some fuel filters are fuel flow directional. Check for arrow that shows fuel flow direction. Reinstall fuel line clamps. See Figure 4.8.



CLAMP FUEL LINE TO PREVENT SPILLAGE

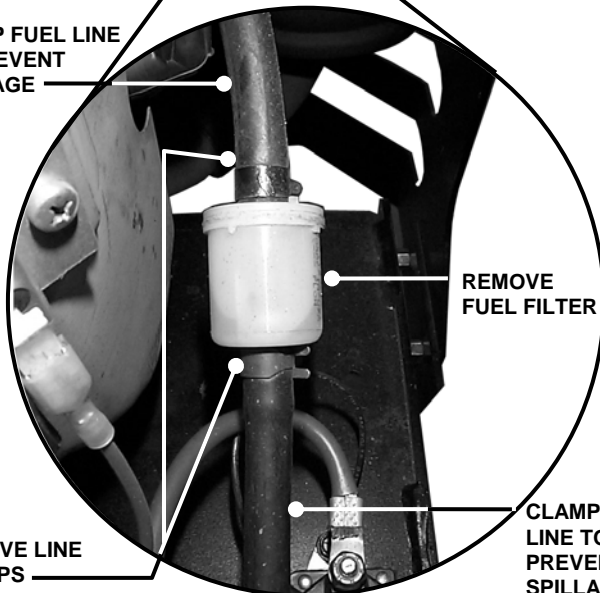
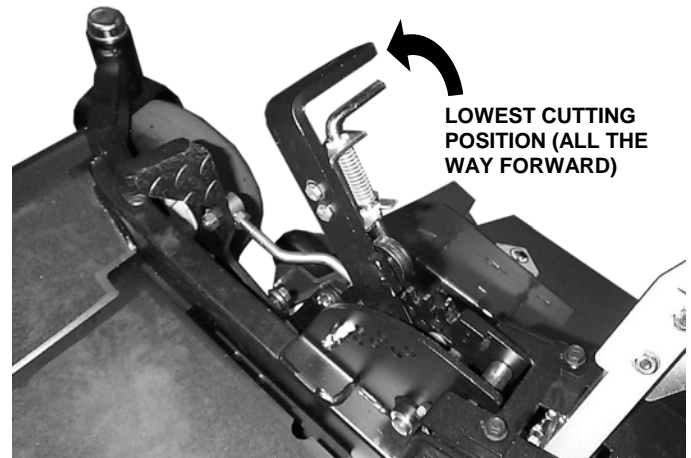

FIGURE 4.8

4.6 DECK REMOVAL

Move power unit/mower deck to an area where the mower deck is to be disconnected. Turn engine "OFF" and remove key from switch. Remove spark plug wire(s) and secure away from spark plug(s). Move motion control levers to the neutral position. Engage parking brake.

1. Move deck lift lever and set the mower deck to the highest cutting position. See Figure 4.9.
2. **IMPORTANT – STORED ENERGY.** Relieve tension on deck lift assist spring by backing off nut on eyebolt. Failure to relieve tension could result in personal injury. See Figure 4.9.
3. Place a wooden block under the front and rear edge of the mower deck.
4. Move deck lift lever and set the mower deck to a lower cutting position until deck rests on wooden blocks. Position the deck to where there is no tension on the deck hanger chains. See Figure 4.9.



POSITION DECK LIFT LEVER IN HIGHEST CUTTING POSITION. PLACE WOODEN BLOCKS UNDER FRONT AND REAR OF DECK. LOWER DECK ONTO BLOCKS

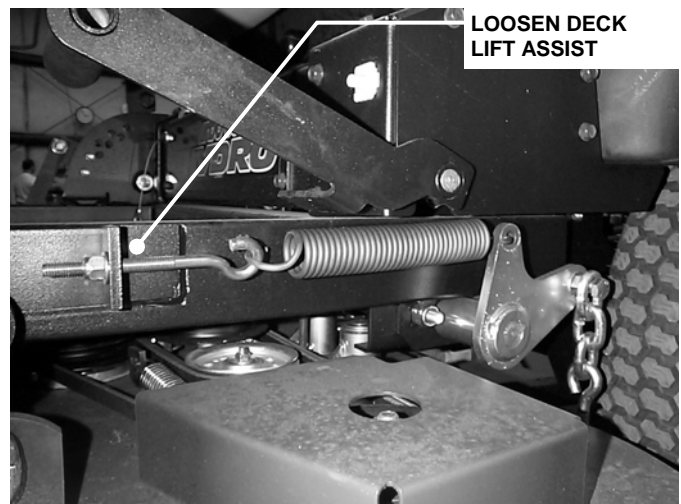

FIGURE 4.9

(Continued On Next Page)

Section 4 - MAINTENANCE

WARNING
DO NOT attempt any maintenance, adjustments or service with engine running. STOP engine. STOP blades. Set parking brake. Remove key. Remove spark plug wires and secure away from spark plugs. Engine and components are HOT. Avoid serious burns, allow sufficient time for all parts to cool.

4.6 DECK REMOVAL (Continued from previous page)

4. Remove inside nuts that secure chain to front lift arm. See Figure 4.10.

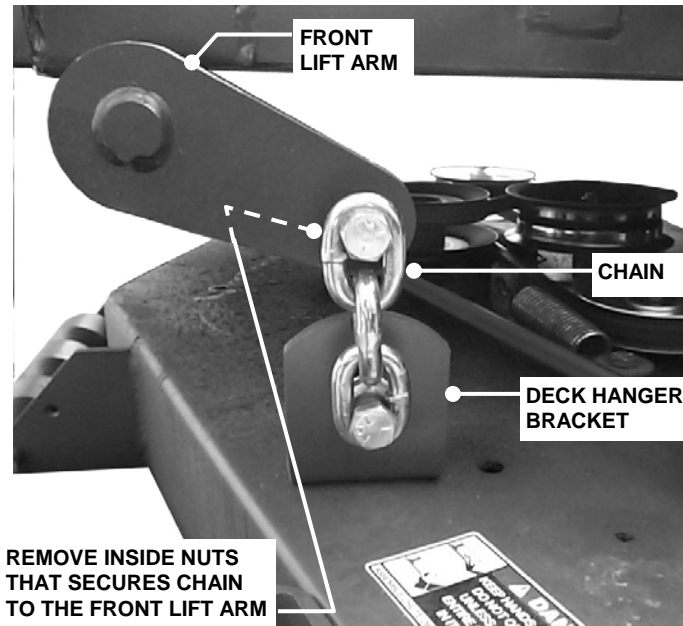

FIGURE 4.10

5. Remove inside nuts that secure chain to rear lift arm. See Figure 4.11.

REMOVE INSIDE NUTS THAT SECURES CHAIN TO THE REAR LIFT ARM

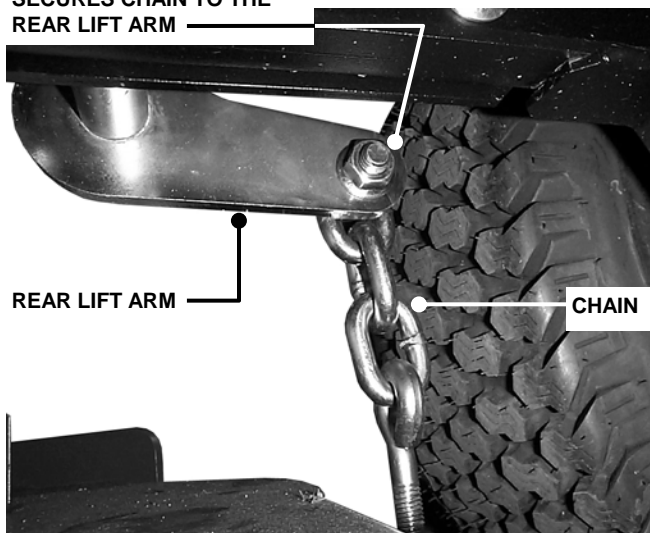

FIGURE 4.11

6. Remove deck drive belt from around deck pulley.
7. Remove bolts and nuts to disconnect both stabilizers from mower deck and power unit. See Figure 4.12 & Figure 4.13.

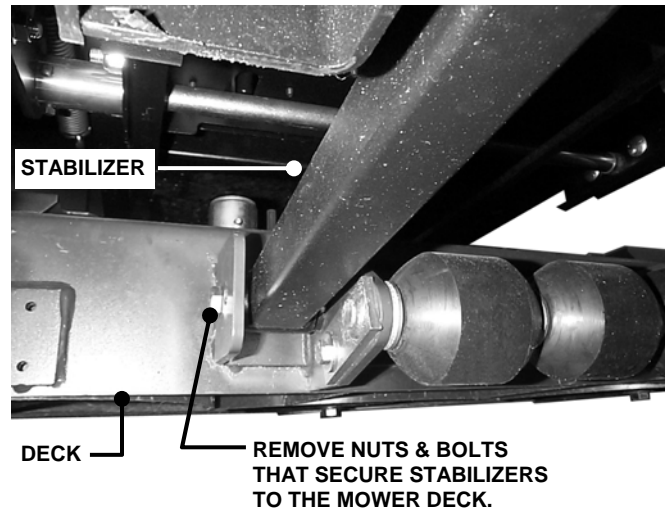

FIGURE 4.12

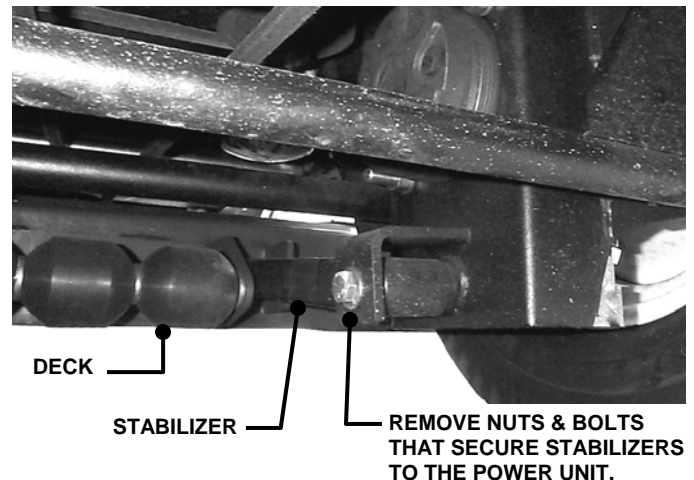

FIGURE 4.13

8. Remove wooden blocks from underneath deck and roll/slide deck from underneath power unit.
9. Reinstall deck in reverse order, of which it was removed. Tighten all nuts and bolts securely.

4.7 HYDRAULIC FLUID FILTERS

IMPORTANT: REFER TO SECTION "HYDRAULIC SYSTEM PURGING" BEFORE PERFORMING FILTER MAINTENANCE.

The first filter change is recommended at 200 hours. After the first change, the recommended interval is every 500 hours. Replace both with approved filters only (Snapper P/N 27164). Install following instructions provided with the filter. Add SAE 20W50 oil to bring the level in the reservoirs to 1 ½" below top of filler neck. Run machine for several minutes and re-check fluid level. Add oil as needed.

Section 5 - ADJUSTMENTS & REPAIR

⚠ DANGER ⚠
Exercise **EXTREME CAUTION** when making this adjustment, due to close proximity of moving parts.

5.1 NEUTRAL POSITION ADJUSTMENTS

The motion control levers control the movement and stopping of the machine. Move the control levers to the center or neutral position to stop machine.

IMPORTANT: Always return both motion control levers with hand assistance to the neutral position. If machine does not come to a complete stop or machine has movement when control levers are moved to the neutral lock position, adjustment must be made.

1. Turn key to "OFF" position.
2. Move motion control levers to the neutral lock position. Refer to Figure 3.7.
3. Raise both rear wheels off the ground. Secure machine with safety blocks.
4. Remove cover screen to expose top of hydro pumps and linkages. See Figure 5.1.
5. Remove both fans from top of hydro pumps.
6. Disconnect motion lever connecting rods from hydro pump activation assembly. See Figure 5.2.

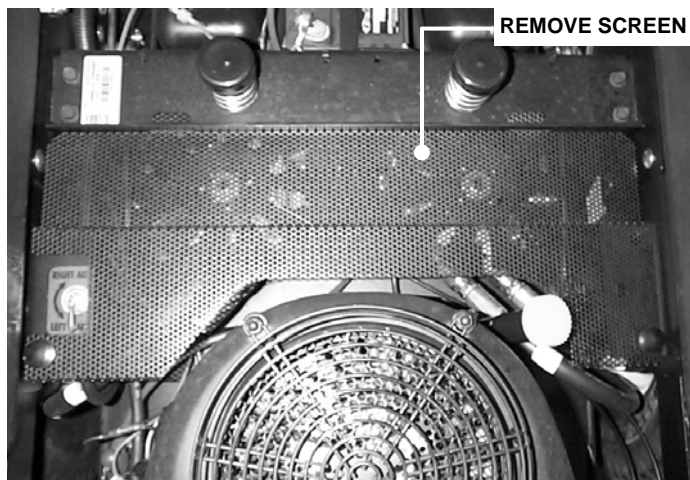

FIGURE 5.1

7. Turn key to start position and start machine. Move engine speed control to the Rabbit "FAST" position
8. Disengage parking brake.
9. Both wheels should not have any movement, not rotating.
10. If wheel(s) are rotating, loosen the hydro pump activation assembly retaining screw. Move activation assembly forward or rearward to stop rotation of wheel. Retighten retaining screw. Repeat this step for other hydro pump. See Figure 5.3.
11. Stop engine.

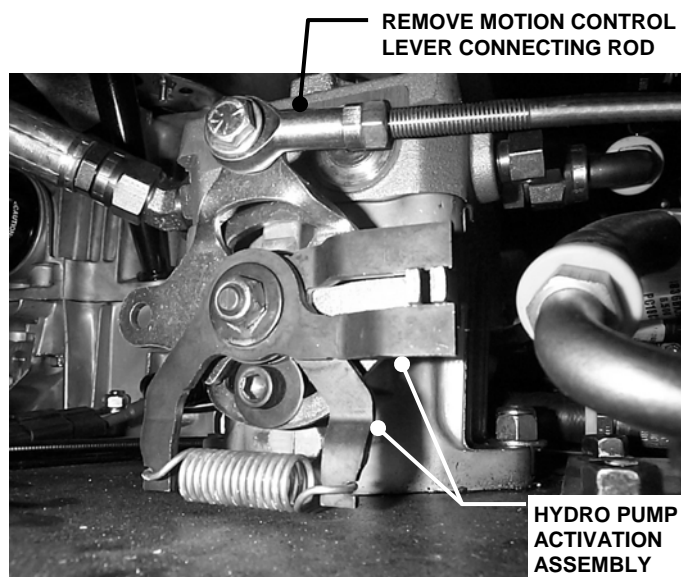

FIGURE 5.2

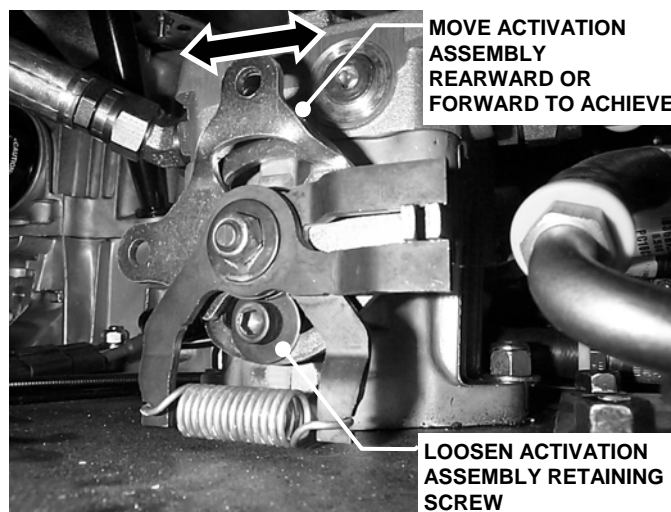

FIGURE 5.3

(Continued On Next Page)

Section 5 - ADJUSTMENTS & REPAIR

5.1 NEUTRAL POSITION ADJUSTMENTS (Continued From Previous Page)

12. With motion control levers remaining in the neutral lock position, See Figure 3.7, hold connecting rod up to the activation assembly and check length of rod. Tie rod end bolt must align with the activation assembly. If bolt is not aligned with the activation assembly, adjust tie rod. Loosen jam nut that secures tie rod. Rotate tie rod in or out to align with hole in activation assembly. Repeat step for other hydro pump. See Figure 5.4.

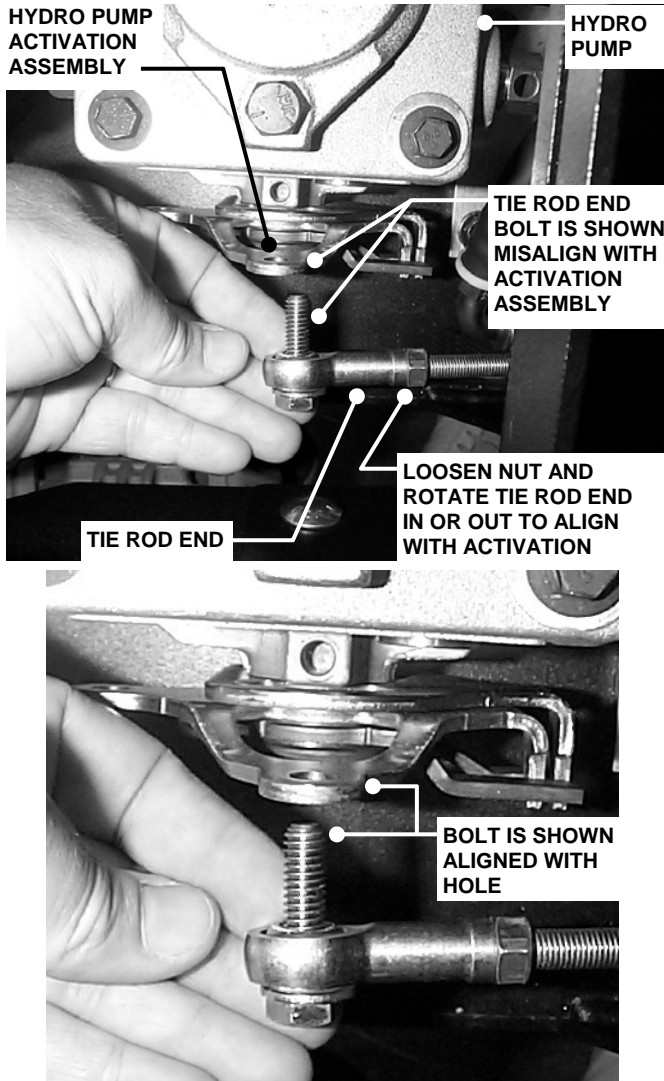

FIGURE 5.4

13. Once tie rod end bolt is aligned with activation assembly insert into hole and reinstall washers and nut that secure bolt to assembly. Tighten securely. Tighten tie rod jam nut securely.

14. Start engine, disengage parking brake, and check rotation of the rear wheels.

15. Reinstall both hydro pump fans. Reinstall washer and bolt. Tighten bolt securely.

16. Reinstall screen and tighten retaining hardware securely.

5.2 MOWER DECK & COMPONENT ADJUSTMENTS

The leveling procedures for the 61 deck differ from the 48 and 52 decks. The 61 deck replaces the two rear eyebolts with slotted brackets, and uses 1 1/4" leveling blocks in place of the 1" blocks. Follow and complete each step carefully.

5.2.1. MOWER DECK ADJUSTMENT (LEVELNESS) SIDE to SIDE and FRONT to REAR

Before making deck leveling adjustments, inflate rear tires to 12 PSI and front tires to 25 PSI. When adjusted correctly, the deck will be level side to side within 1/8", have a low cut setting of approximately 1" (1 1/4" for 61 deck) and the blades pitched approximately 3/16" higher at the rear.

1. Place machine on a smooth level surface.
2. Check side to side level by rotating blades until tips are pointing to the sides of the deck. Check the measurement of outside blade tips to the ground on both blades. The measurement of each of the outside blade tips should be within 1/8" of each other. If measurement of the blade tips is not within 1/8", adjustment should be made.
3. Move deck lift lever and set the mower deck to the highest cutting position.
4. Relieve tension on deck lift assist spring by loosening nut on eyebolt. Refer to Section "Removing Deck".
5. Place 1" blocks (1 1/4" for 61 deck) under the front and rear edge of the mower deck.
6. Move deck lift lever and set the mower deck to the lowest cutting position.
6. Loosen the nuts and bolts that secure both front deck support chains. Adjust chains until tight and retighten bolts and nuts. Torque to 20 to 30 ft. lbs. See Figure 5.5.

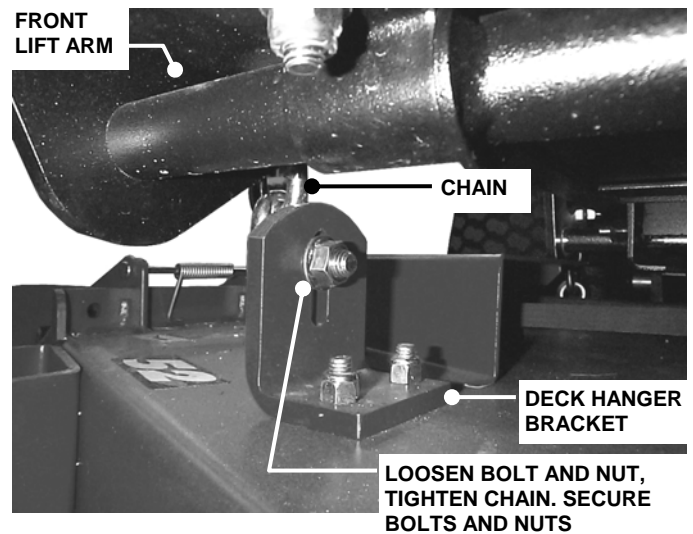

FIGURE 5.5

Section 5 - ADJUSTMENTS & REPAIR

WARNING
DO NOT attempt any maintenance, adjustments or service with engine running. STOP engine. STOP blades. Set brake. Remove key. Remove spark plug wires and secure away from spark plugs. Engine and components are HOT. Avoid serious burns, allow sufficient time for all parts to cool.

5.2.1. MOWER DECK ADJUSTMENT (LEVELNESS) SIDE to SIDE and FRONT to REAR

7. Loosen the nuts that secure both rear deck support eyebolts (slotted brackets on 61, See Figure 5.5). Adjust to remove slack from both rear chains. Tighten nuts securely. See Figure 5.6.

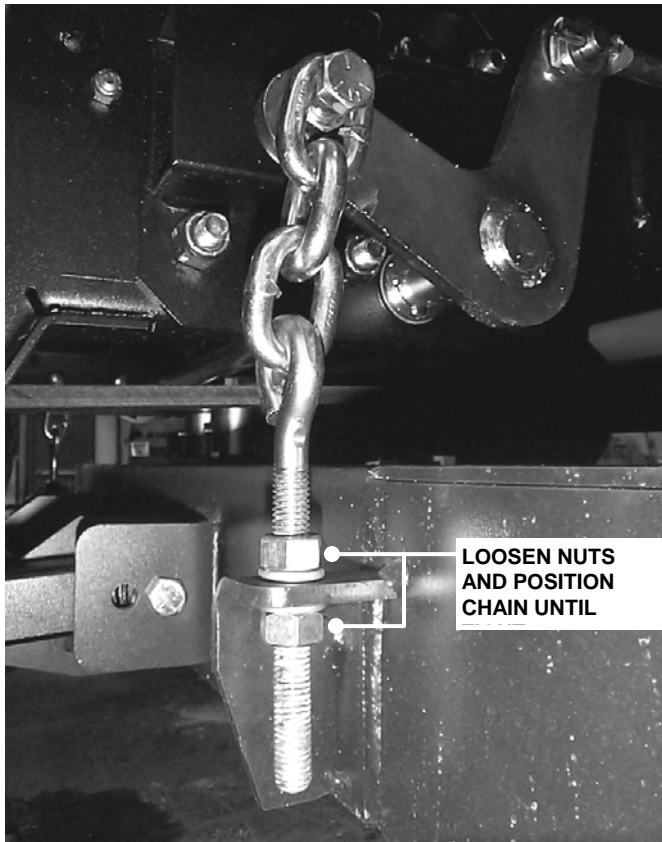

FIGURE 5.6

8. Move deck lift lever and set the mower deck to the highest cutting position and recheck side to side blade tip dimensions. The difference between the two should be 1/8" or less.

NOTE: The deck timing rod is preset at the factory and requires no adjustments. See Figure 5.7.

9. The leveling blocks used in Step 4 should result in a proper deck pitch. If a pitch adjustment is required, use the two rear deck support eyebolts (slotted brackets on 61). Adjust up or down as required.

10. Reinstall deck lift assist spring. Place deck in highest cutting position. Tighten nut on eyebolt until 1 1/4" of threads (2 1/4" for 61" decks) protrude past end of nut. See Figure 4.9.

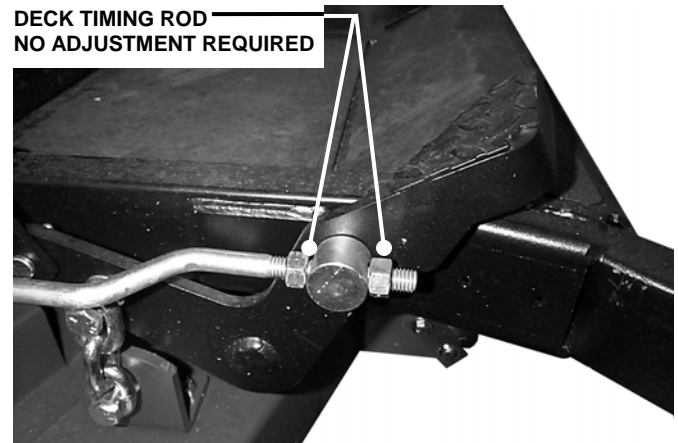

FIGURE 5.7

WARNING
Do not operate this machine if the brakes are not functioning properly!

5.3 PARKING BRAKE ADJUSTMENT

The parking brake can be adjusted by rotating hex nut clockwise to increase brake tension. If this adjustment does not result in proper braking action contact your authorized SNAPPER dealer for corrective action. See Figure 5.8.

1. Disengage parking brake. Measure the relaxed length of the brake spring.
2. Engage parking brake. Length of spring should decrease 3/8". Adjustment is required if less than 3/8".
3. Loosen jam nut.
4. Tighten hex nut to compress brake spring 3/8". Tighten jam nut to secure the hex nut in place. Disengage and engage parking brake and recheck brake spring compression measurement. Repeat previous steps for other wheel. See Figure 5.8.

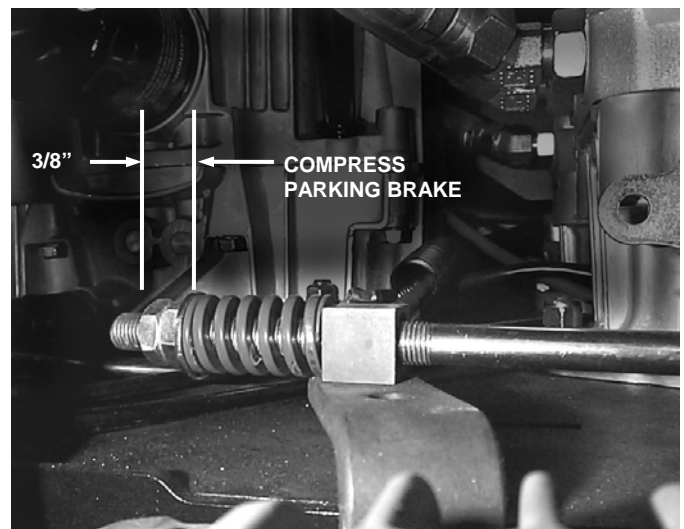

FIGURE 5.8

Section 5 - ADJUSTMENTS & REPAIR

WARNING

DO NOT attempt any maintenance, adjustments or service with engine running. STOP engine. STOP blades. Set brake. Remove key. Remove spark plug wires and secure away from spark plugs. Engine and components are HOT. Avoid serious burns, allow sufficient time for all parts to cool.

5.3 TRACTION BELT TENSION

The traction drive belt tension does not require adjustment. If the belts are slipping, they will have to be replaced.

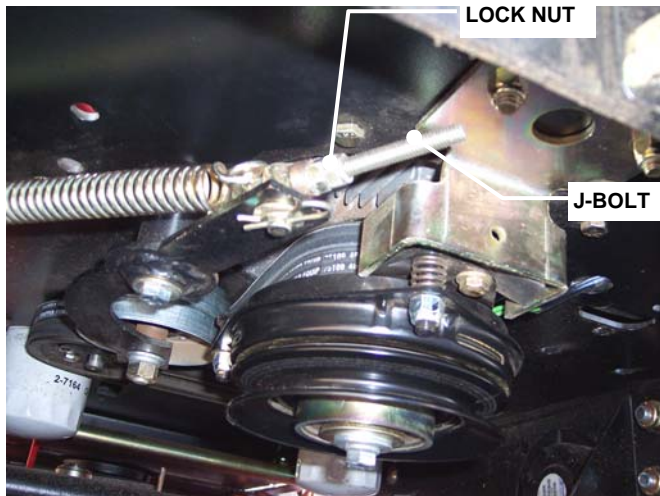

FIGURE 5.9

5.4 TRACTION BELT REPLACEMENT

1. Remove clutch to deck belt. See Figure 5.10.
2. Turn lock nut out to the end of J-Bolt, reducing spring tension. Unhook traction idler spring from bolt in frame. See Figure 5.9
3. Remove anti-rotation bracket. See Figure 5.10
4. Disconnect the electric clutch from main wire harness.
5. Remove traction belts from around engine pulley and hydro pumps.
6. Install new belts and route around engine pulley and hydro pump pulleys.
7. Reconnect electric clutch to main wire harness.
8. Reinstall anti-rotation bracket and tighten nuts securely.
9. Reattach traction idler spring. Run lock nut all the way to the end of the threads on the J-Bolt. See Figure 5.10.
10. Reinstall electric clutch to deck belt onto electric clutch.

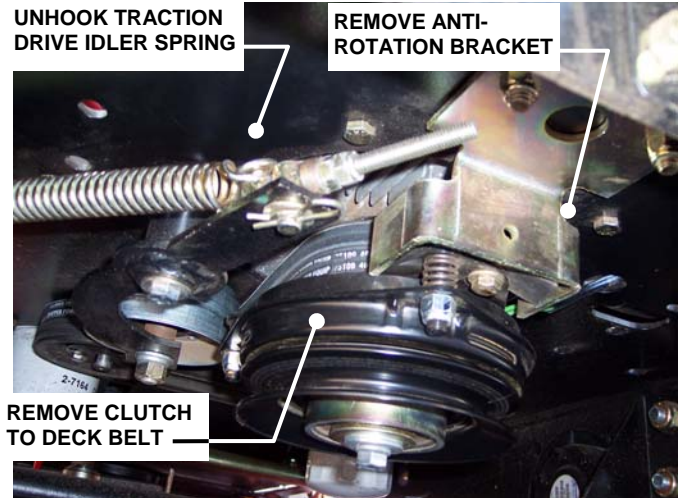

FIGURE 5.10

5.5 BLADE BRAKE/ELECTRIC CLUTCH ADJUSTMENT

The blade switch engages the electric clutch when pulled out to the "ON" position. When the blade switch is in the "ON" position the cutting blade(s) are engaged. The blade switch disengages the electric clutch when the blade switch is pushed in to the "OFF" position. When the blade switch is in the "OFF" position the cutting blade(s) are disengaged. The electric clutch is adjustable. The blades should stop rotation in 7 seconds or less. If the electric clutch fails to stop the blades rotation in 7 seconds, adjustment is necessary.

1. Insert a feeler gauge into the three slots on the electric clutch.
2. Check gap through all three slots in the side of the clutch. The gap should be set at .015.
3. If gap is incorrect rotate nuts in or out to achieve the correct gap. See Figure 5.11.

NOTE: Electric Clutch is shown removed from the machine. Removal is not necessary for adjustment.

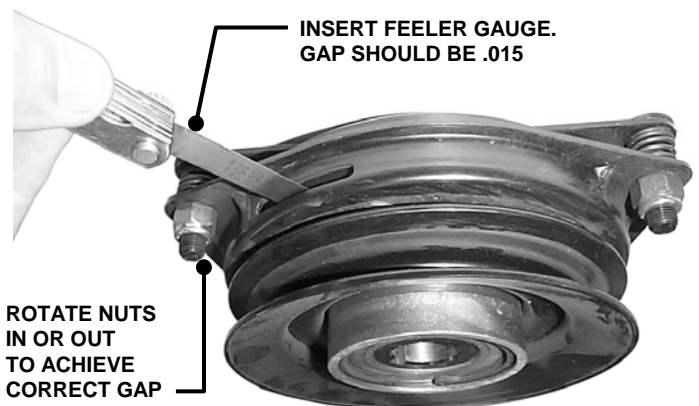

FIGURE 5.11

Section 5 - ADJUSTMENTS & REPAIR

5.6 TRACKING ADJUSTMENT

If the machine does not track straight when the Motion Control Levers are in the maximum forward speed position, perform the following adjustment. Rear tire pressure must be set to 12 PSI before making this adjustment.

1. Loosen bolts that secure adjustment plates and slide plates all the way forward. Retighten bolts.
2. Start machine and drive in smooth flat open area at maximum forward speed.
3. If machine tracks to the right, loosen bolts that secure the left adjustment plate. Move plate rearward to slow the left wheel. Retighten bolts.
4. If machine tracks to the left, loosen bolts that secure the right adjustment plate. Move plate rearward to slow the right wheel down. Retighten bolts. See Figure 5.12.
5. Drive machine again. Repeat adjustment as necessary until machine tracks straight.

LOOSEN BOLTS.
SLIDE PLATE TO
MAKE MACHINE
TRACK STRAIGHT

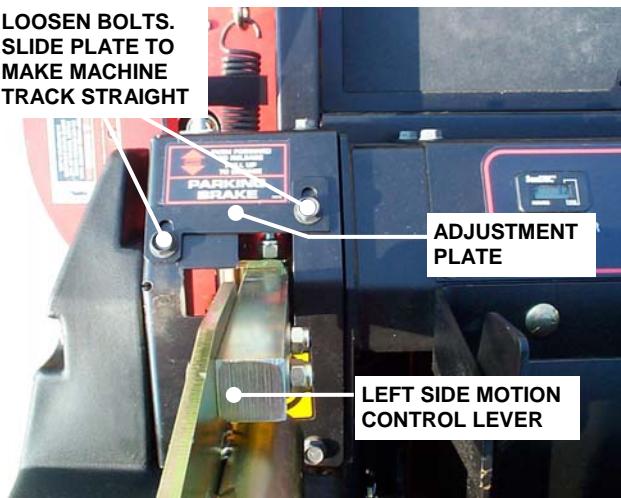

FIGURE 5.12

5.7 MOWER DRIVE BELT REPLACEMENT

Inspect mower drive belt. Replace belt if it shows signs of excessive wear, damage and/or is broken.

5.7.1. BELT REMOVAL

1. Remove power unit footrest.
2. The engine to deck belt must be removed before the deck belt can be removed. Remove engine to deck belt.
3. Disconnect deck belt tension spring.
4. Remove old deck belt. Note the belt routing. See Figure 5.12.

5.7.2. BELT REPLACEMENT

1. The deck belt must be installed first and the engine to deck belt installed last.
2. Route deck belt around blade pulleys and idler pulley in the same position as old belt was removed. See Figure 5.13.
3. Reconnect idler pulley spring.
4. Reinstall engine to deck belt.
5. Reinstall power unit footrest.

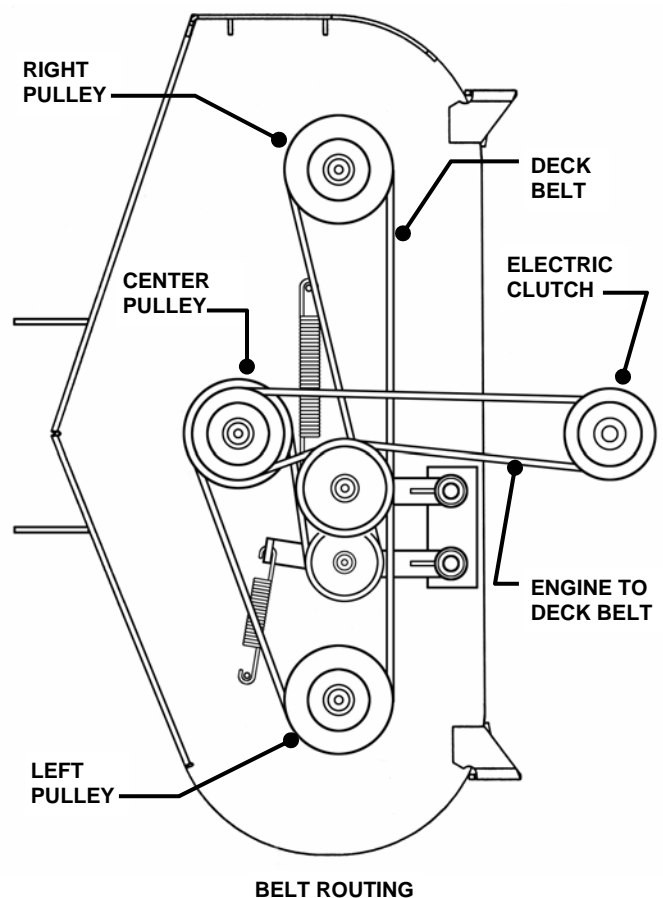

FIGURE 5.13

Section 5 - ADJUSTMENTS & REPAIR

5.8 ENGINE ADJUSTMENTS & REPAIR

Refer to the engine owner's manual for engine adjustments and/or repairs.

5.9 MOWER BLADE REPLACEMENT

5.9.1. BLADE WEAR LIMITS

1. Inspect blade frequently for signs of excessive wear or damage. Replace blade when it reaches the wear limit. See Figure 5.14.

5.9.2. BLADE SHARPENING

1. Remove blade. See Figure 5.15.
2. Inspect condition of blade. See Figure 5.14.
3. If blade is in good condition, sharpen at 22 to 28 degrees. DO NOT sharpen beyond original cutting edge. See Figure 5.16.
4. Check blade balance after sharpening. If necessary, correct blade balance by grinding the heavy end of blade.

IMPORTANT: Blade balancing should be performed by a qualified dealer.

5. Reinstall blade. See Figure 5.15. Torque blade mounting bolts to recommended range of 70 to 80 ft. lbs.

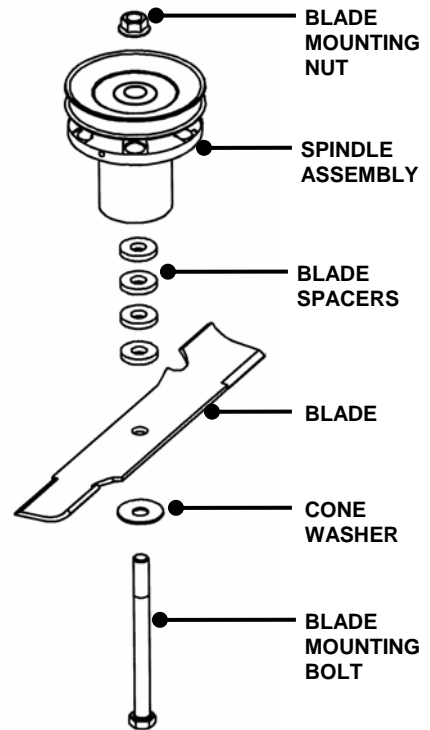

FIGURE 5.15

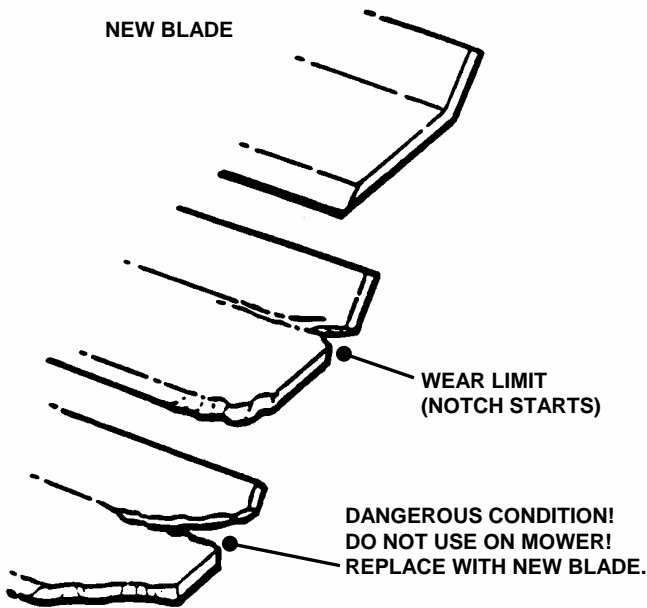

FIGURE 5.14

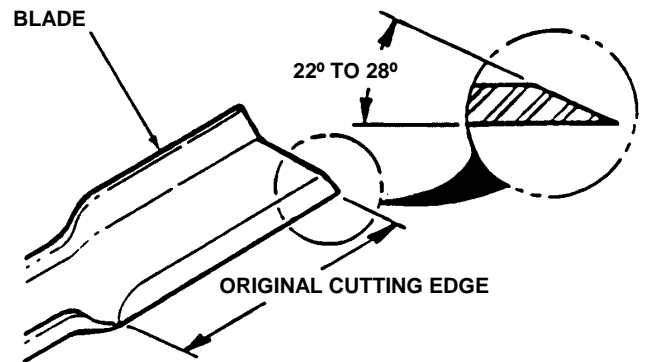

FIGURE 5.16

Section 5 - ADJUSTMENTS & REPAIR

WARNING

Shield the positive terminal with terminal cover located on battery harness. This prevents metal from touching the positive terminal, which could cause sparks. Cables must be connected to battery terminals in the proper position. RED (Positive) cable must go to the (+) terminal. BLACK (Negative) cable must go to the (-) terminal. If battery is removed, DO NOT operate engine without insulating Positive + battery cable terminal with electrical tape, or sparking from the battery cables can result.

5.10 BATTERY

5.10.1. BATTERY REMOVAL

1. Remove battery retainer. See Figure 5.17.
2. Slide terminal cover away from positive terminal.
3. Observe and note cable positions on battery. Disconnect cables from battery terminals, disconnecting BLACK (Negative) cable first and RED (Positive) last. Retain mounting bolts and nuts. See Figure 5.17.

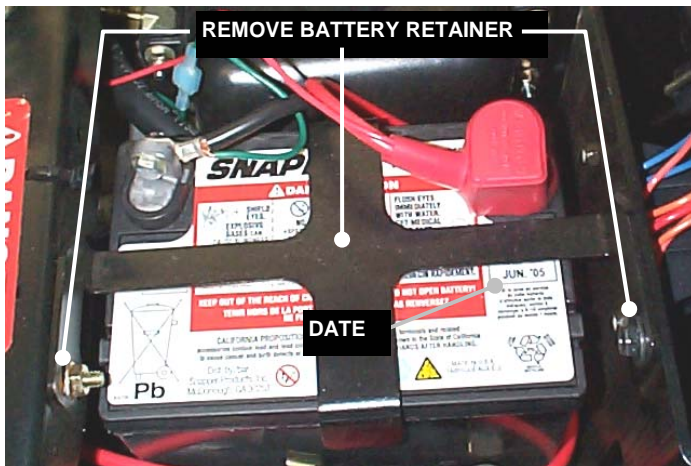

FIGURE 5.17

5.10.2. BATTERY INSTALLATION

1. Position battery into battery compartment.
2. Connect cables to battery terminals. Connect RED (Positive) cable first. Connect BLACK (Negative) cable last. See Figure 5.18.
3. Reinstall battery retainer and positive terminal cover. See Figure 5.17.

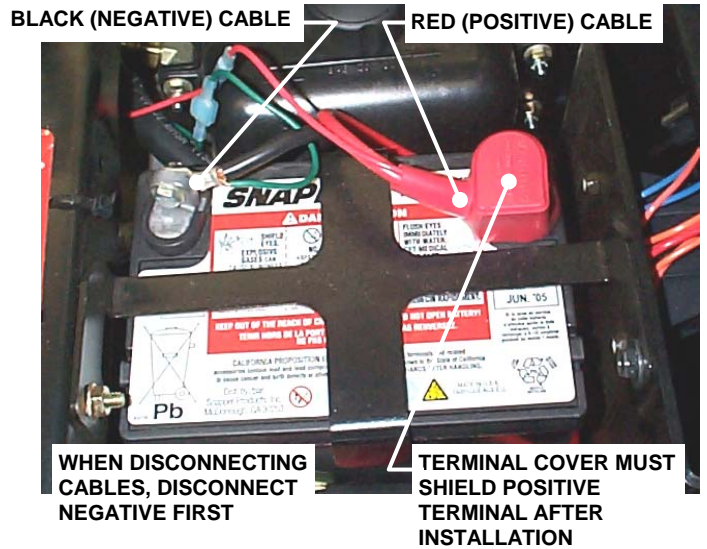

FIGURE 5.18

5.10.3. BATTERY CHARGING

NOTE: The battery in this machine is maintenance-free. It has been filled to the proper level with acid and is sealed. Do not attempt to open battery.

1. Remove battery.
2. Place battery in a well-ventilated area on a level, non-concrete surface.
3. Connect battery charger to battery terminals. RED to positive (+) terminal and BLACK to negative (-) terminal.
4. Slow charge battery at 6-10 amps for 1 hour.
5. If battery will not accept charge or is partially charged after 1 hour of charging, replace with new battery.

WARNING

Keep all sparks, flame and fire away from area when charging battery.

Section 5 - ADJUSTMENTS & REPAIR

5.10.4. BATTERY TESTING

1. Remove battery. Refer to Section "BATTERY REMOVAL".
2. Using a voltmeter, check the battery's state of charge by comparing the voltmeter reading with the chart below. (Remember to hook the positive (red) lead of the voltmeter to the battery's positive terminal, and the negative lead to the negative terminal.)

Battery Condition Chart	
State of Charge	Digital Voltmeter
100% Charged w/ Sulfate Stop	12.80v
100% Charged	12.60v
75% Charged	12.40v
50% Charged	12.10v
25% Charged	11.90v
0% Charged	Less than 11.80v

5.10.5. NEW BATTERY PREPARATION

1. Remove battery from carton.
2. Place battery in a well ventilated area on a level non-concrete surface.
3. Check date on battery label. See Figure 5.17. If battery is placed into service after the date shown, charge battery. Refer to section "BATTERY CHARGING".
4. After charging (if required), slide battery partially into battery housing.
5. Connect positive (+) cable (red) first, from wiring harness to the positive terminal (+) on battery using bolt and nut provided in hardware bag. Connect negative (-) cable (black) last, to negative terminal (-) on battery using bolt and nut. Apply a small amount of grease over terminals to prevent corrosion.
6. Install battery retainer and positive terminal cover.

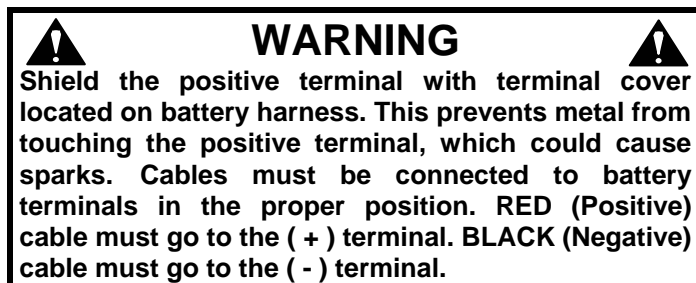
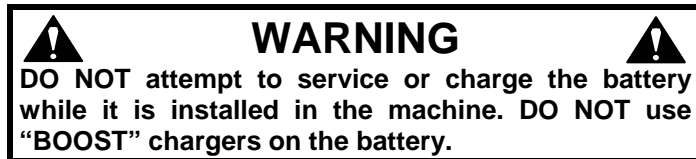

Section 5 - ADJUSTMENTS & REPAIR

5.11 MOWER SPINDLES (Field Serviceable Spindles) BEARING REPLACEMENT

In the event that a spindle bearing requires replacement, the SNAPPER Field Serviceable Spindles have been designed so that no special tools or presses are required.

1. Remove belt. Loosen blade nut and remove. Allow blade bolt, washer, blade and four spacers to drop down out of the spindle housing. See Figure 5.19.

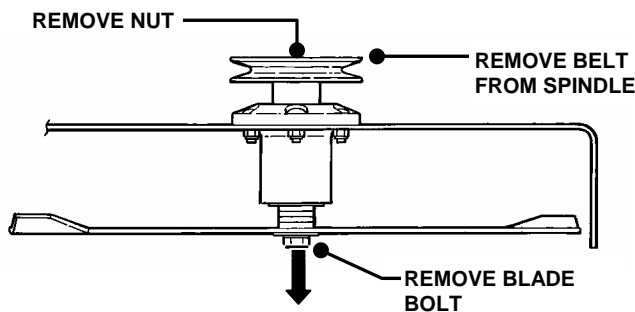

FIGURE 5.19

2. Remove spindle pulley from spindle shaft.
3. Locate circular retaining ring on spindle shaft at top bearing. Remove retaining ring. Allow spindle shaft to drop out of housing.
4. Top and bottom bearings are now removable. Pull out on inner race to slide bearing from housing. See Figure 5.20.
5. Thoroughly clean all parts removing all old contaminated grease.
6. Install new bottom bearing first.
7. NOTE: The bearing is sealed/shielded on one side only. The bottom bearing must be installed with the sealed/shielded side DOWN.
8. Insert spindle shaft up through the bottom bearing. Slide spacer down over spindle shaft.
9. Install new top bearing. Install the top bearing with the seal/shield UP.
10. Slide circular retaining ring down spindle shaft until it fully locks into groove on shaft.
11. Apply a generous amount of general-purpose grease to the concave side of the nylos seal. Install the nylos seal with concave greased side down.
12. Place spindle pulley and spacer on top of spindle shaft.
13. Reinstall blade bolt, washer, blade and four spacers. See Figure 5.15
14. Torque blade bolt and nut to 70 to 80 ft. lbs.
15. Pump grease into spindle housing until grease purges from vent on housing.
16. After the first 5 hours of operation, grease spindle housing to insure it is full, then every 25 hours.

IMPORTANT: Spindle housing must be filled with grease before operating mower. Failure to fill housing will cause premature bearing failure.

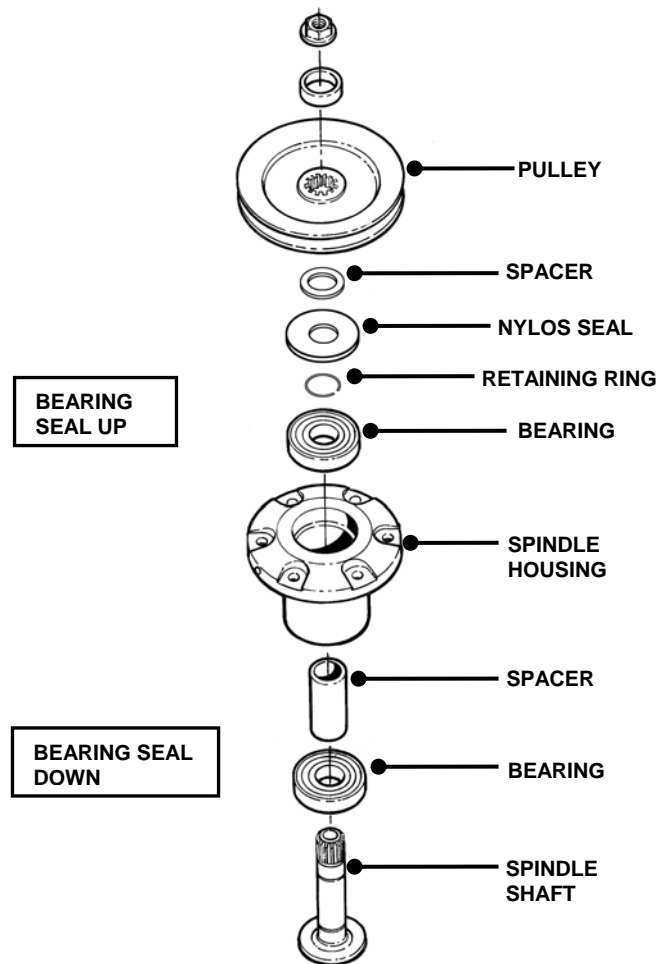

FIGURE 5.20

Section 5 - ADJUSTMENTS & REPAIR

5.12 HYDRAULIC SYSTEM, PURGING

After replacing or repairing hydraulic system components, one or both of the wheel drives may not pull properly. This is likely to be caused by air entrapped in the system. If you experience a pulling issue after completing repairs, perform the following procedure to purge the air from one or both of the hydraulic drive systems.

IMPORTANT: WHEN REPLACING THE HYDRAULIC FLUID FILTERS, PRE-FILL BOTH WITH OIL (SAE 20W50 API SL) BEFORE INSTALLING. PRE-FILLING THE FILTERS WITH OIL WILL REDUCE OR POSSIBLY ELIMINATE THE NEED TO PURGE THE SYSTEM OF ENTRAPPED AIR

1. Locate hydraulic reservoir underneath operator's seat. After thoroughly cleaning the area around the top of the reservoir, remove filler cap. Bring fluid to proper level (1 ½" below the top of the filler neck). With engine off, add SAE 20W50 automotive oil. See Figure 4.6.
2. Open pressure relief valve on hydraulic pump, turning counter clockwise 2 full turns. See Figure 3.3.
3. Carefully raise the rear of the machine so the wheels are off of the ground. Securely block the machine to prevent it from falling.
4. While seated in the operator's position, start the engine. Place engine speed control in FAST position.
5. Release parking brake and move motion control levers out of the neutral lock position.
6. Slowly move motion control levers to the full forward and then to the full reward positions. Repeat this process 6 times.
7. Stop engine and wait for all rotation to stop before leaving the operator's position.
8. Close pressure relief valve on hydraulic pump, turning clockwise. Tighten snugly.
9. With pressure relief valve closed, repeat Steps 4 thru 7.
10. Remove blocks and lower rear of machine.
11. Check fluid level in reservoir. Add SAE 20W50 automotive oil as required to bring fluid level to 1 ½" from top of filler neck. Do Not over fill.
12. Install and tighten filler cap.



TROUBLESHOOTING

PROBLEM	PROBABLE CAUSE	CORRECTIVE ACTION
Starter Will Not Crank Engine	1. Battery dead.	1. Service battery.
	2. Blown fuse.	2. Replace fuse.
	3. Electrical connections loose or corroded.	3. Clean and check connections for good contact.
	4. Defective ignition switch.	4. Contact authorized SNAPPER dealer.
Engine Will Not Start	1. Blade engagement switch in the "ON" position.	1. Move blade engagement switch to "OFF".
	2. Park brake not set or Operator not seated.	2. Set park brake and Operator in Operator Seat.
	3. Motion Controls not in Neutral Lock Position.	3. Place Motion Controls in Neutral Lock Position.
	4. Fuel tank empty.	4. Fill fuel tank with fresh fuel.
	5. Engine needs choking.	5. Move choke control to "CHOKE" position.
	6. Spark plug wire disconnected.	6. Place spark plug wire onto spark plug.
	7. Battery weak or dead.	7. Service battery.
	8. Faulty parking brake, blade or ignition switch.	8. Contact authorized SNAPPER dealer.
Engine Stalls After Running	1. Operator not in seat.	1. Sit in operator's seat.
	2. Choke control in the "CHOKE" position.	2. Move choke control to "OFF" position.
	3. Fuel tank empty.	3. Fill with fuel to proper level.
	4. Engine air pre-cleaner and or air cleaner dirty.	4. Clean free of all debris.
	5. Spark plug defective or gap set improperly.	5. Service spark plug.
	6. Fuel filter stopped up.	6. Replace fuel filter.
	7. Water, debris or stale fuel in fuel system.	7. Drain and clean fuel system.
Engine Loses Power	1. Excessive load on engine.	1. Lessen load.
	2. Engine air pre-cleaner or air cleaner dirty.	2. Clean or replace filters.
	3. Engine oil level low.	3. Fill with engine oil to proper level.
	4. Engine cooling fins & air intake screen excessively dirty.	4. Clean cooling fins, air intake screen of all debris.
	5. Spark plug faulty.	5. Service spark plug.
	6. Water, debris or stale fuel in fuel system.	6. Drain and clean fuel system.
Engine Backfires When Turned To "STOP"	1. Throttle control set too "FAST".	1. Set throttle control to "SLOW" and allow engine to idle. Then, turn key to "OFF".
Excessive Vibration	1. Damaged or bent mower blades.	1. Service mower blade(s).
	2. Loose blade components.	2. Service and tighten loose parts.
	3. Worn or damaged components.	3. Inspect all belts and pulleys.
	4. Loose or missing air lift (if equipped).	4. Replace air lifts. Tighten to proper torque.

(Trouble Shooting Continued on Next Page)

TROUBLESHOOTING

PROBLEM	PROBABLE CAUSE	CORRECTIVE ACTION
Machine Will Not Move Loss Of Traction	1. Motion Control Levers in the neutral "N" position.	1. Move Motion Controls to desired speed
	2. Hydro. Pumps in roll release setting.	2. Tighten relief valves.
	3. Low transmission hydraulic oil level.	3. Bring hydraulic oil to proper level.
	4. Parking Brake engaged.	4. Move parking brake to disengaged position.
	5. Traction drive belts require replacement.	5. Replace traction drive belts.
Blade(s) Not Cutting	1. Blade engagement switch in the "OFF" position.	1. Move blade switch to the "ON" position.
	2. Clutch belt slipping.	2. Replace clutch belt.
	3. Mower belt slipping.	3. Replace mower belt.
	4. Electric clutch not functioning.	4. Contact authorized SNAPPER dealer.
Cutting Grass Improperly	1. Uneven tire pressure.	1. Bring to proper pressure.
	2. Cutting height too low or high.	2. Adjust cutting height.
	3. Engine speed too slow.	3. Move throttle control to "FAST" position.
	4. Forward speed too fast.	4. Move joystick to a slower speed.
	5. Terraced cut, side to side.	5. Adjust side to side level.
	6. Excessive deck pitch, front to rear.	6. Adjust front to rear level.
	7. Cutting blade(s) dull or damaged.	7. Sharpen cutting edges or replace blade(s).
	8. Blade belt slipping.	8. Replace blade belt.
	9. Check electric clutch.	9. Adjust to proper specifications.
	10. Check clutch belt.	10. Replace clutch belt.
	11. Check gearbox for damage.	11. Contact authorized SNAPPER dealer.
Poor Grass Discharge	1. Engine speed too slow.	1. Move throttle control to "FAST" position.
	2. Forward speed too fast.	2. Move joystick to a slower speed.
	3. Grass is wet.	3. Mow when grass is dry.
	4. Excessively worn or damaged blade(s).	4. Service mower blade(s).
	5. Build up of grass clippings and debris under deck.	5. Clean deck.
	6. Improper blade(s) installed on deck.	6. Install proper SNAPPER blades.
	7. Blade(s) installed improperly on deck.	7. Install blades properly.
Battery Will Not Charge	1. Poor cable connections.	1. Clean cables and battery terminals.
	2. Bad battery cell(s).	2. Replace with new battery.
	3. Faulty alternator.	3. Contact engine manufacturer's dealer.

SERVICE SCHEDULE

ITEM	SERVICE PERFORMED	REF. NUMBER	EACH USE	5 HRS	25 HRS	50 HRS	100 HRS	EACH SEASON
Engine Oil	Check Oil Level	Page 9	X					
	Initial Oil Change	Page 14		X				
	Periodic Oil Change	Page 15				X*		
Air Cleaner	Clean or Replace	Engine Manual			X**			
Spark Plug	Replace	Engine Manual					X	
Fuel Filter	Replace	Page 17					X	
Engine Cooling System	Clean Shroud & Fins	Engine Manual & Page 16					X**	
Battery	Charge Battery	Page 25						X
	Testing Battery	Pages 26						X
Tires	Check Pressures	Page 9	X			X		X
Drive Belts	Check For Wear And Tension	Page 15			X	X		X
Mower Blades	Check For Wear, Damage & Replacement	Pages 24	X					
Mower Deck	Clean Debris Accumulation	Page 15	X					
Lubrication Points	Grease or Oil	Pages 15-16			X			X
Hydrostatic Trans. Oil	Check Oil Level	Page 16				X		X
Hydrostatic Trans. Filter	Replace Filter	Page 18	First Change at 200 Hours. Thereafter every 500 Hours.					
Safety Interlock System	Check System For Proper Function	Page 13	Check Periodically during Operating Season					

* Change oil every 25 hours when operating under heavy load or high temperatures.

**Clean more often under dusty conditions or when air debris is present

MAINTENANCE PARTS

5.9. MAINTENANCE/REPLACEMENT PARTS

MAINTENANCE/REPLACEMENT PARTS	48" DECK	52" DECK	61" DECK
Mower Blades – High Lift	2-9247 (3)	2-9246 (3)	2-9251
Mower Blades – Medium Lift	1-7043 (3)	1-7037 (3)	1-0781
Mower Blades – Low Lift	N.A.	7-3395 (3)	7-3396
Mower Deck Belt	2-9261	2-9266	2-9268
Electric Clutch to Mower Deck Belt	7-5083	7-5083	7-5623
Hydro Pumps, Drive Belts	7-5626 (2)		
Battery	7-5911		

SNAPPER®

2 YEAR LIMITED WARRANTY

For two (2) years from purchase date for the original purchaser's use, **SNAPPER**, through any authorized **SNAPPER** dealer will replace, free of charge (except for taxes where applicable), any part or parts found upon examination by the factory at McDonough, Georgia, to be defective in material or workmanship or both.

For ninety (90) days from purchase date for the original purchaser's rental use, **SNAPPER**, through any authorized **SNAPPER** dealer will replace, free of charge (except for taxes where applicable), any part or parts found upon examination by the factory at McDonough, Georgia, to be defective in material or workmanship or both

All transportation costs incurred by the purchaser in submitting material to an authorized **SNAPPER** dealer for replacement under this warranty must be paid by the purchaser.

This warranty does not apply to transmissions, to engines and their components, and batteries, as these items are warranted separately. This warranty does not apply to parts that have been damaged by accident, alteration, abuse, improper lubrication, normal wear, or other cause beyond the control of **SNAPPER**. This warranty does not cover any machine or component that has been altered or modified, changing safety, performance, or durability.

Batteries have a one (1) year warranty period with free replacement if required for one (1) year from the original purchase date. **SNAPPER** will not be responsible for any installation cost incurred. The battery warranty only covers original equipment batteries and does not cover damage to the battery or machine caused by neglect or abuse, destruction by fire, explosion, freezing, overcharging, improper maintenance, or use of improper electrolyte.

There is no other express warranty.

DISCLAIMER OF WARRANTY

Implied warranties, including those of merchantability and fitness for a particular purpose, are limited to two (2) years from purchase date for the original purchaser's non-rental use, and ninety (90) days from the purchase date for the original purchaser's rental use, and up to the extent permitted by law and all implied warranties are excluded. This is the exclusive remedy. Liabilities for consequential damages, under any and all warranties are excluded.

Some states do not allow limitations on how long an implied warranty lasts, or do not allow the exclusion or limitation of incidental or consequential damages, so the above limitation or exclusion may not apply to you.

This warranty gives you specific legal rights, and you may also have other rights which vary from state to state.

WARNING: THE USE OF REPLACEMENT PARTS OTHER THAN GENUINE SNAPPER PARTS MAY IMPAIR THE SAFETY OF SNAPPER PRODUCTS AND WILL VOID ANY LIABILITY AND WARRANTY BY SNAPPER ASSOCIATED WITH THE USE OF SUCH PARTS.

IMPORTANT: Please fill out the attached **SNAPPER** Product Registration Card immediately and mail to:
Snapper's Product Registration Center, P.O. Box 1379, McDonough, Georgia. 30253

PRIMARY MAINTENANCE

SNAPPER®

vs. DIRT!

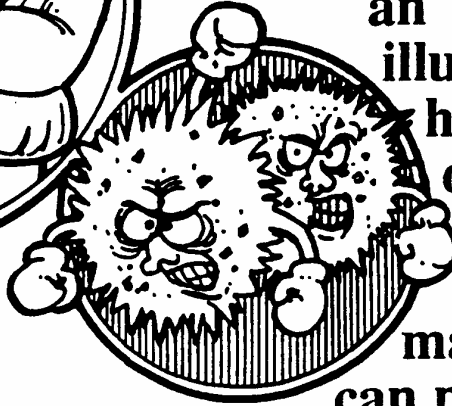
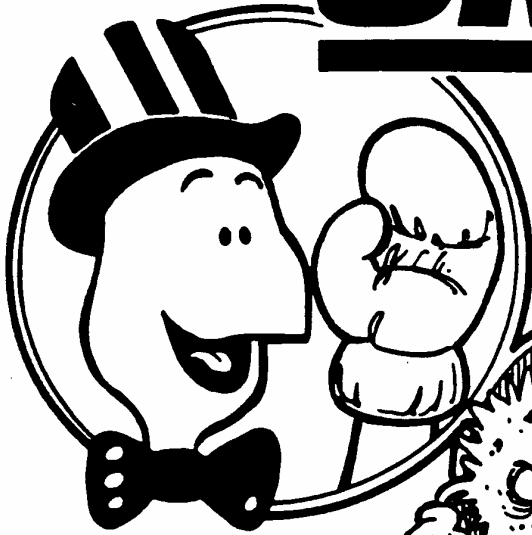

an illustration of how dirt can damage your engine & how reasonable maintenance can protect it!

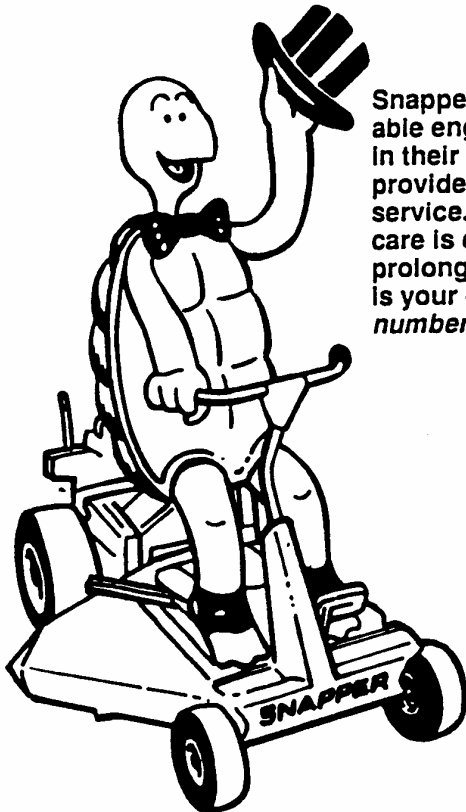

Snapper uses the best available engines and components in their products in order to provide long, satisfactory service. However, proper care is essential in prolonging engine life. Dirt is your engine's enemy number 1!

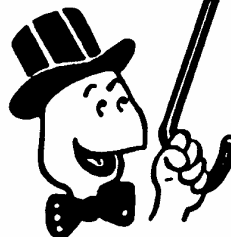

The engine on your Snapper product spends its entire life operating close to the ground at high speed creating a virtual storm of dust and dirt!

PRIMARY MAINTENANCE

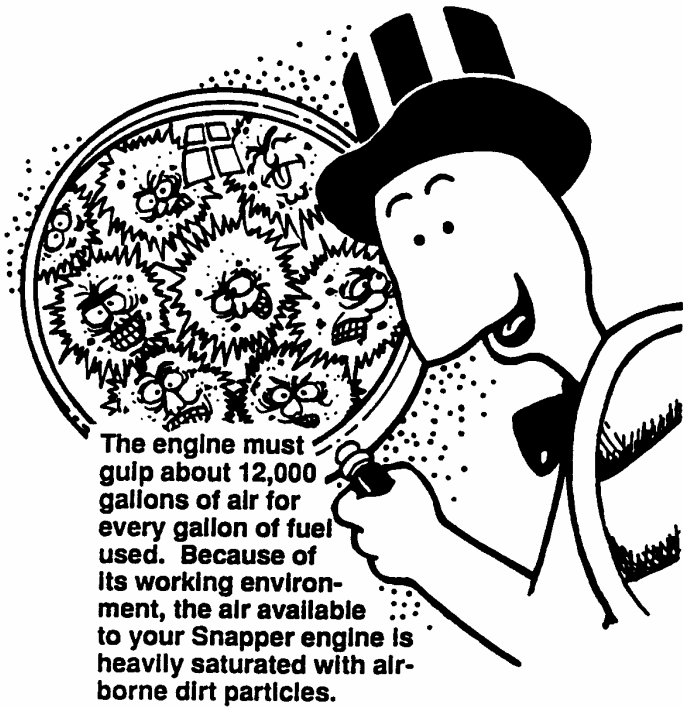

The engine must gulp about 12,000 gallons of air for every gallon of fuel used. Because of its working environment, the air available to your Snapper engine is heavily saturated with airborne dirt particles.

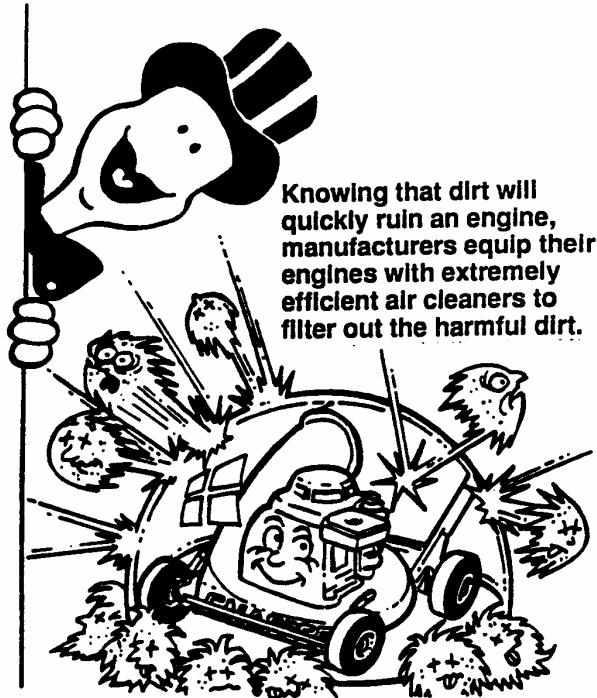

Knowing that dirt will quickly ruin an engine, manufacturers equip their engines with extremely efficient air cleaners to filter out the harmful dirt.

As the dirt particles are stopped, they build up and begin to clog the outside of the filter. This reduces the amount of air available to the engine and causes an over-rich fuel mixture which results in the following adverse effects:

An improperly serviced, dirt clogged air cleaner will:

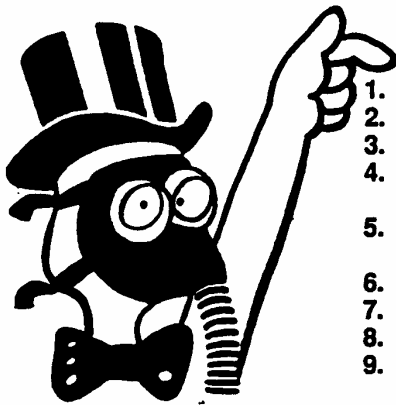

1. Increase fuel consumption
2. cause power loss
3. result in hard starting
4. create smoke from unburned fuel
5. produce carbon build-up internally
6. foul spark plug electrodes
7. score cylinder walls
8. burn valves
9. wear out the engine prematurely
10. COST YOU MONEY!

Damage caused by a poorly serviced air cleaner is not covered under the engine warranties. So, save yourself unnecessary expenses and undue aggravation by keeping the air cleaner properly serviced at the intervals specified in the engine owner's manual.

It doesn't take long to service an air cleaner. Follow the specific instructions in the engine owner's manual for the type filter used. Prevent dirt from falling into the carburetor intake when servicing your air cleaner. Make sure components are installed in correct sequence after servicing to prevent unfiltered air from entering the engine. Some servicing hints on several common types are:

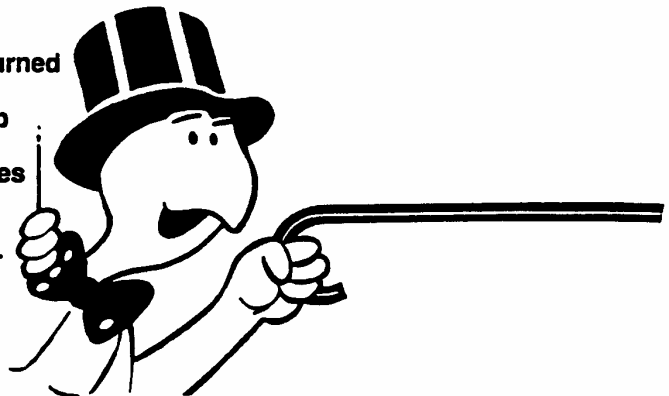

PRIMARY MAINTENANCE

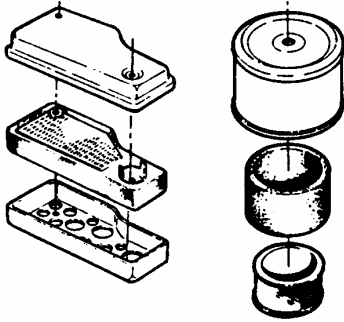

Generally, wash foam-type filters in a dishwashing detergent and water solution. Rinse and wring dry, then saturate with oil and squeeze out excess. *Failure to re-oil this type filter will ruin the engine.*

Clean paper elements by tapping lightly. Blowing with air will rupture paper elements.

Use a flashlight to detect clogged or torn paper elements - replace if damaged in any way.



Air is also needed to keep your engine cool. Dirt, dust & debris build up to restrict and clog cooling air intake screens and fins. Clean screens and fins at frequent intervals. The engine blower housing and shrouds should be removed at least once each season or more often under dry, dusty conditions for a thorough cleaning of fins.

Failure to keep external surfaces clean not only presents fire hazards, but causes overheating and resulting engine damages such as:

1. distorted valve guides
2. sticking valves
3. scuffed, scored cylinder walls
4. overspeeding
5. loss of power
6. complete failure of engine.

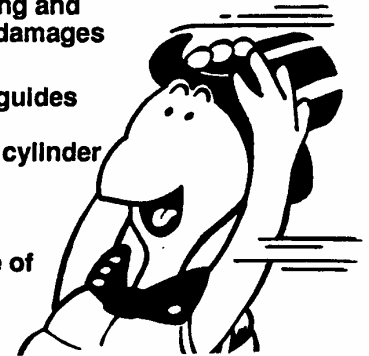

Dirt can also be introduced into an engine in dirty fuel from a contaminated container. Always use clean fresh fuel from a clean container to guard against dirt, sludge and water contamination.

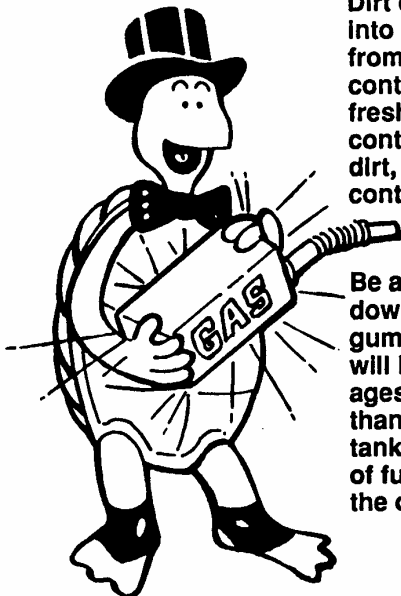

Be aware that fuel breaks down in storage and forms gummy compounds which will block carburetor passages. Never use fuel more than 3 months old. Drain tank then run the engine out of fuel before storing during the off-season.

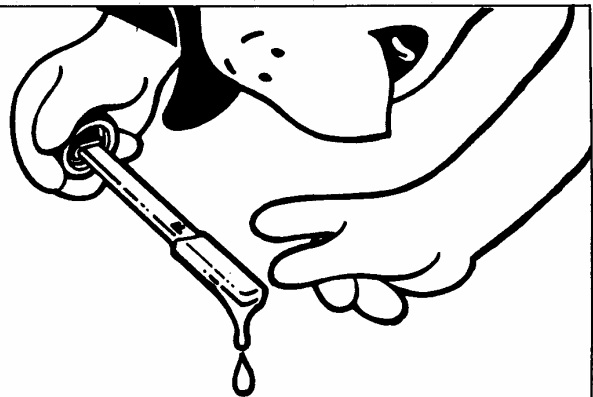

An engine must also have proper lubrication. All engines use some oil. On 4-cycle engines, **CHECK OIL LEVEL BEFORE EACH START-UP.** Wipe area clean around the oil check plug or dipstick opening to keep dirt from falling into the engine when checking the oil. Always check with the machine on a level surface. On engines with dipstick, keep the level up to, but not over, the **FULL** mark. When adding oil, allow time for all of the oil to flow down the fill tube to prevent a false full reading when the level could actually be low and result in engine damage.

PRIMARY MAINTENANCE

On 4-cycle engines with an oil level plug, don't be fooled into thinking the engine has sufficient lubricating oil if you can see "some" oil in the opening - the level should always be brought up to the point of overflowing at the top of the fill hole.

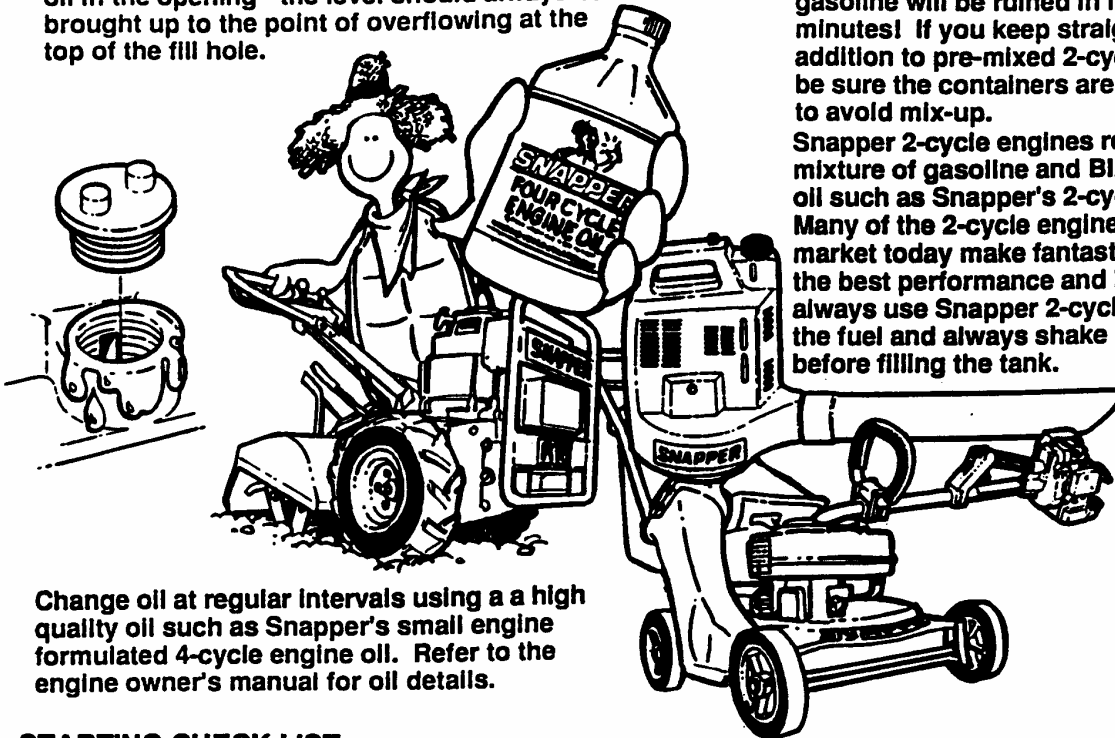

On 2-cycle engines, lubrication must be provided by an exact mixture of gasoline and 2-cycle air-cooled engine oil. A 2-cycle engine that is mistakenly run on straight gasoline will be ruined in less than 5 minutes! If you keep straight gasoline in addition to pre-mixed 2-cycle engine fuel, be sure the containers are clearly marked to avoid mix-up.

Snapper 2-cycle engines require a 32 to 1 mixture of gasoline and BIA certified TC-W oil such as Snapper's 2-cycle engine oil. Many of the 2-cycle engine oils on the market today make fantastic claims, but for the best performance and long engine life, always use Snapper 2-cycle oil. Pre-mix the fuel and always shake the container before filling the tank.

Change oil at regular intervals using a high quality oil such as Snapper's small engine formulated 4-cycle engine oil. Refer to the engine owner's manual for oil details.

STARTING CHECK LIST

- | | |
|-------------------------------|--|
| 1. Engine Oil | <ul style="list-style-type: none"> • To full level (4-cycle) • Properly mixed with gas (2 cycle) |
| 2. Air Cleaner | <ul style="list-style-type: none"> • Clean and properly serviced • Full fresh clean gasoline |
| 3. Fuel Tank | <ul style="list-style-type: none"> • Fuel valve open • Cap vent open • Inline filter clean |
| 4. Choke | <ul style="list-style-type: none"> • Operating properly |
| 5. Primer (on some engines) | <ul style="list-style-type: none"> • Used properly |
| 6. Safety Inter-lock Switches | <ul style="list-style-type: none"> • In proper position • All wires properly connected |
| 7. Switch & Blade Control | <ul style="list-style-type: none"> • Switch On • Blade control properly positioned on walk mower |
| 8. Spark plug | <ul style="list-style-type: none"> • Wire connected • Good connection • Start position |
| 9. Throttle control | |
| 10. Blade | <ul style="list-style-type: none"> • Properly installed and torqued • Sharpened |
| 11. Muffler | <ul style="list-style-type: none"> • Good condition • Not clogged • Grass & leaves cleaned away |

Read and follow all safety instructions in safety booklets and manuals.

Keep in mind that dirt is your engine's *enemy* #1 both internally and externally! Internally, dirt will quickly ruin an engine and externally it will cause overheating and resulting internal damages. Damage caused by improper lubrication, poor air cleaner service or overheating due to dirt cannot be covered under warranty.

It only takes a few moments to service the engine (and equipment) on a routine basis but the rewards will be a quick starting, responsive engine that will provide long satisfactory service with minimum maintenance cost. The prestart checklist in the next column and instructions in your Snapper Operator's Manual are designated to help you keep your Snapper in top operating condition with minimum effort!

SNAPPER PRODUCT REGISTRATION FORM

**IMPORTANT: KEEP THIS INFORMATION FOR YOUR PERSONAL RECORDS
(Complete the following information on your Snapper purchase)**

Model Number _____

Serial Number _____

Date of Purchase _____

Retailer _____

Retailer's Phone Number _____

It is very important that you register your purchase with Snapper to ensure warranty coverage. Please mail your product registration card to:

Snapper at P.O. Box 1379, McDonough, Georgia 30253.

Or you may register on line at www.snapper.com.

You can contact us at our web site or if you would like to speak with a Customer Service Representative. Call us at the Snapper Customer Relations Center. For faster service please have your Serial Number and Model Number available.

Call the Snapper Customer Relations Center at 1-800-935-2967.

Safety Instructions & Operator's Manual for

SNAPPER®

MID MOUNT Z-RIDER

ZERO TURNING

HYDRO DRIVE

SERIES 2

IMPORTANT

Snapper products are built using engines that meet or exceed all applicable emissions requirements on the date manufactured. The labels on those engines contain very important emissions information and critical safety warnings. Read, Understand, and Follow all warnings and instructions in this manual, the engine manual, and on the machine, engine and attachments. If you have any questions about your Snapper product, contact your local authorized Snapper dealer or contact Snapper Customer Service at Snapper, McDonough, GA. 30253. Phone: (1-800-935-2967).



WARNING

BATTERY POSTS, TERMINALS AND RELATED ACCESSORIES CONTAIN LEAD AND LEAD COMPOUNDS, CHEMICALS KNOWN TO THE STATE OF CALIFORNIA TO CAUSE CANCER AND BIRTH DEFECTS OR OTHER REPRODUCTIVE HARM. WASH HANDS AFTER HANDLING.



WARNING

ENGINE EXHAUST, SOME OF ITS CONSTITUENTS, AND CERTAIN VEHICLE COMPONENTS CONTAIN OR EMIT CHEMICALS KNOWN TO THE STATE OF CALIFORNIA TO CAUSE CANCER OR OTHER REPRODUCTIVE HARM.

SNAPPER® McDonough, GA., 30253 U.S.A.